

WCDMA 3G GPS Tracker

For Vehicle

用户手册

User Manual

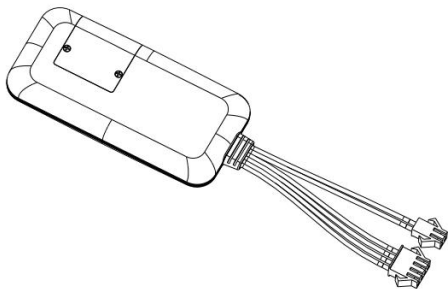

MODEL : TK119-3G

WCDMA 3G GPS 车载定位器

一、	功能和规格.....	1
1.1	产品功能.....	1
1.2	产品规格.....	2
二、	结构和配件.....	3
2.1	产品结构.....	3
2.2	产品配件.....	3
三、	安装 SIM 流量卡.....	4
四、	设备安装.....	5
4.1	注意事项.....	5
4.2	接线方法.....	7
4.3	继电器安装.....	8
五、	开关机.....	9
5.1	开机.....	9
5.2	状态指示.....	9
5.3	关机.....	10
六、	查询、断油/电.....	11
6.1	平台查询.....	11
6.2	短信查询.....	11
6.3	断油/电.....	11
七、	设备报警.....	12

7.1	振动报警.....	12
7.2	碰撞/跌落报警.....	12
7.3	速度报警.....	12
7.4	位移报警.....	12
7.5	电子围栏报警.....	12
7.6	剪线报警.....	13
7.7	低电报警.....	13
八、	设备配置.....	13
九、	故障排除.....	13
9.1	无法连接服务平台.....	13
9.2	平台显示离线状态.....	14
9.3	长时间不定位.....	14
9.4	定位漂移严重.....	15
9.5	指令接收异常.....	15
十、	保修细则.....	15
10.1	特别声明.....	15
10.2	保修期.....	16
10.3	售后服务.....	16

I. Product Features.....	16
II. Components and Accessories...	18
III. SIM card Installation.....	19
IV. Terminal Installation.....	22
4.1 Install the terminal.....	22
4.2 Terminal wiring definition....	24
4.3 Relay wiring.....	26
V. Power On / Off.....	27
5.1 Power on.....	27
5.2 LED Indicators.....	27
5.3 Power off.....	29
VI. Inquiry/Monitoring/Cut Oil.....	29
6.1 Inquiry by service platform..	29
6.2 Inquiry by SMS.....	29
6.3 Cut Oil /Restore.....	30
VII. Terminal Alarm.....	30
7.1 Vibration Alarm.....	30
7.2 Collision / falling Alarm.....	31
7.3 Speed Alarm.....	31
7.4 Shift Alarm.....	31

7.5 Geo-fence Alarm.....	31
7.6 Power disconnect Alarm.....	31
7.7 Low battery Alarm.....	31
VIII. Terminal Setting.....	32
IX. Trouble shooting.....	32
9.1 Cannot connect platform.....	32
9.2 Offline status.....	33
9.3 No positioned.....	34
9.4 Position drift.....	35
9.5 Commands receiving abnormally.....	35
X. Warranty rules.....	35
10.1 Special statement.....	35
10.2 Warranty period.....	36
10.3 After sales.....	36
Warranty Card/保修卡.....	37

感谢您选用购买本机器，请您在使用之前认真阅读本说明书，以便得到正确的安装方法及操作指南，产品外观及配色如有改动，请以实物为准，恕不另行通知。

TK119-3G定位器借助GPS卫星定位系统、WCDMA/GPRS通信和互联网，通过强大的服务平台实现对车辆进行实时远程监测和控制，帮助客户实现透明管理、降低成本、保障安全、提高效率的目标。目前已广泛应用于商业运输、物流配送、企业车队、汽车租赁、智能交通、工程机械、船舶航运、应急指挥、抢险施救、军警安检、智慧城市。

一、功能和规格

1.1 产品功能

- WCDMA 三频，GSM 四频，全球通用
- 电压输入范围：7-36 V DC
- 支持 GPS / LBS 双模定位
- 定时上传定位数据，浏览器、手机 APP、短信均可查询
- ACC 点火检测，车辆状态提示
- 内置锂电池，可剪线报警、低电报警
- 内置加速传感器，碰撞、跌落等报警
- 电子围栏、速度、位移等多种报警
- 可外接继电器，用于车辆远程断油/电
- 可扩展输入输出端口，增加扩展功能
- 支持多种协议，可对接客户平台
- OTA 程序远程升级
- 防水性能等级 IP67

1.2 产品规格

工作电压	12/ 24 / 36 VDC
工作电流	<50mA@12V
待机电流	<10mA@12V
GPS 定位精度	5-15 米
LBS 定位精度	200 米左右(取决基站密度)
GPS 频段	1575MHz
GSM 频段	850 / 900 / 1800 / 1900 MHz
WCDMA 频段	W850 / W1900 / W2100 MHz
热/温/冷启动	<3 秒, <15 秒, <60 秒
内置电池	70mAh
外形尺寸, mm	87(L)X 41.6(W) X 12(H)
工作环境温度	-20℃~70℃
工作环境湿度	20%~80%RH
机器净重	50g

二、结构和配件

2.1 产品结构

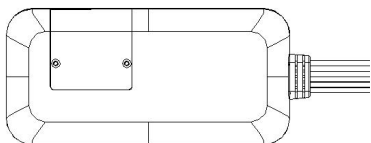

机身正面（接收面，对向天空）



机身背面

2.2 产品配件

（以下图片仅供参考，以实物为准）



电源线（标配）



继电器（选配）

三、安装 SIM 流量卡

打开包装盒, 检查设备型号是否正确, 配件是否齐全, 否则请联络你的经销商; 设备需要一张 SIM 卡, SIM 卡的选择请参考经销商的意见;

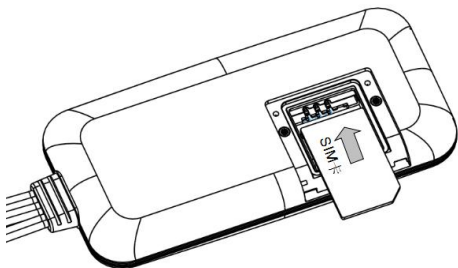

翻开卡座盖子

装入 SIM 卡

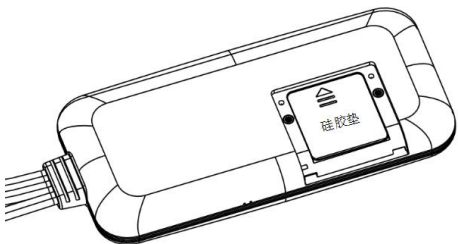

将 SIM 卡座防水硅胶垫片垫上

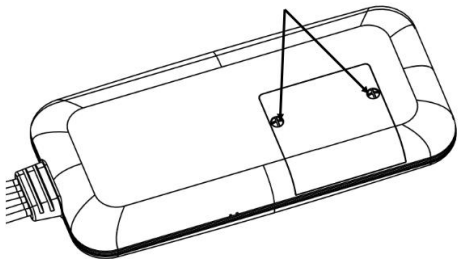

确认底部两个卡扣已经卡住外壳后,将固定螺丝打进 SIM 卡盖上的两个螺丝孔内锁死卡盖。

注意：

- 在安装或取出 SIM 卡前，请先断开设备电源，
- SIM 卡需要开通流量功能。
- 电话查询功能需要 SIM 卡开通来电显示。
- 若您的 SIM 卡已启用“SIM 卡锁(PIN)”，请参考您的手机用户手册取消“SIM 卡锁(PIN)”。
- 请确保 SIM 卡有足够的余额。

四、设备安装

4.1 注意事项

- 建议由经销商指定的专业机构进行隐藏式安装。
- 避免窃贼破坏，设备选位应尽量隐蔽。

- 避免与发射源放在一起，如倒车雷达、防盗器及其他车载通讯设备。
- 建议用宽海棉强力双面胶粘贴，亦可使用扎带固定，或其它可靠固定方式。
- 设备内置 GPS 天线，安装时应确保接收面向上（朝向天空），且上方无金属物遮挡，否则可能会削弱天线信号，造成设备工作异常。

建议安装位置：

- 1) 前挡风玻璃下方装饰板内隐藏处；
- 2) 前仪表盘（表皮为非金属材质）周围隐蔽处；
- 3) 后挡风玻璃下方饰板下；

4.2 接线方法

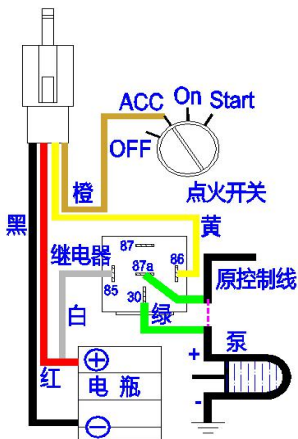

4.2.1 电源线及控制接口

本设备标准供电为 7V-36VDC，请选用原厂提供的电源线，红色线为电源正极，黑色为电源负极；安装时电源负极请选择单独接地或搭铁，勿与其他地线共接。

ACC 线（橙色线）接车辆的 ACC 开关，可使服务平台获知车辆准确的点火状态；也可将 ACC 线直接与电源正极并接，维持高电平，此时服务平台识别车辆一直处于点火状态。

断油电控制线（黄色线）接继电器上的 86 端（即继电器插座上的细黄线）。将继电器用扎带固定在防水及地面水溅不到的地方；或用胶袋罩住继电器。

4.2.2 外围接口（依视向）

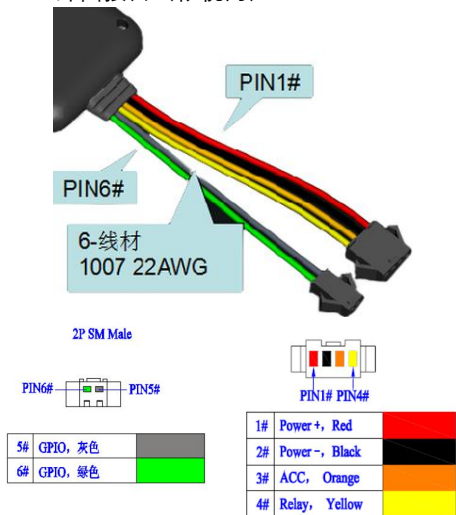

4.3 继电器安装

断油/电 继电器接线方法：

4.3.1 86 端和 85 端 分别接汽车/电动车电源正极 (+12V/+24V) 和设备继电器控制线。

4.3.2 将油泵/电路 正极连接线剪断，油泵正极端串接在继电器常闭 87a 端（继电器常开则接 87 端），另一端接继电器公共 30 端 如图示。



继电器接线示意图（注：4 脚继电器没有 87 脚）

注：一定要注意机车电瓶电压是否与继电器的工作电压相符，否则可能会烧坏继电器或工作异常。

五、开关机

5.1 开机

如设备已插入有效的 SIM 卡，接好外接电源后，设备将自动开机。

5.2 状态指示

设备自动搜索网络信号时，红灯（WCDMA/GSM 指示灯）为快闪；当搜到信号且正确登录运营商网络

时，红灯变为慢闪。

设备自动搜索 GPS 卫星信号时，蓝灯（GPS 指示灯）为快闪；当搜到卫星信号且已经定位时，蓝灯变为慢闪。

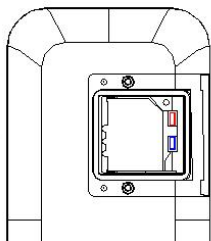

WCDMA/GSM 灯

GPS 灯

1、**红灯**（WCDMA / GSM 状态指示）

快闪	WCDMA / GSM 网络搜索
慢闪	WCDMA / GSM 正常工作

2、**蓝灯**（GPS 状态指示）

快闪	GPS 卫星搜索
慢闪	GPS 已经定位

5.3 关机

切断外部电源，然后取出 SIM 卡，设备关机。

六、查询、断油/电

6.1 平台查询

6.1.1 浏览器平台

您可通过浏览器上网登录设备定位服务平台来查看车辆的位置，设备定位服务平台网址可咨询您的经销商。

6.1.2 智能手机客户端

我们已经为您准备好了安卓客户端（Android），苹果客户端（iOS），以便您使用智能手机查询车辆，安装包请向您的经销商索取。

注：请在您的经销商处获取服务平台的使用说明。

6.2 短信查询

您可编写位置查询短信发送至设备 SIM 卡获取车辆位置信息，设备将回复最后一次定位的位置信息或地图链接。短信格式请参见《操作指令》。

6.3 断油/电

切断油路

服务平台或管理员短信下发断油指令，在保证车辆处于安全行驶的前提下，切断车辆的油或电路，达到将车辆强行停止并无法启动的目的。

为保证安全，设备仅在 GPS 处于有效定位状态，且满足车辆时速小于 20km/h 或车辆静止的条件下才会执行断油操作。

恢复油路

设备将执行恢复油路指令。

七、设备报警

7.1 振动报警

报警条件：当车辆发生振动时。

注：需要设定振动灵敏度和持续时间，有设防/撤防开关。

7.2 碰撞/跌落报警

报警条件：当设备所处车辆发生碰撞、跌落时。

7.3 速度报警

报警条件：当车辆超过和低于设定速度时。

注：需要设置速度上限和速度下限。

7.4 位移报警

报警条件：当车辆处于熄火状态时，设备产生了设定值以上位移。

注：此报警需要在车辆熄灭状态下才被触发。

注：需要设置位移距离。

7.5 电子围栏报警

报警条件：当车辆进/出/跨越电子围栏时。

注：需要设置围栏条件、围栏种类等等。

7.6 剪线报警

报警条件：当设备外接电源被切断时。

7.7 低电报警

报警条件：当设备外接电源被切断且内置电池电量低于一定值。

注：当出现以上警情时，设备会向服务平台发出报警，如果设备已经设置相应管理员号码，设备还将向管理员号码发出报警短信。

注：7.1、7.3、7.4、7.5 和 7.7 报警需设置相关参数，设置详情见：《操作指令》

八、设备配置

请参考《操作指令》

九、故障排除

9.1 无法连接服务平台

设备首次安装后，服务平台一直显示未上线。请检查设备：

- 1) 主电源接线是否正确，注意不要接到汽车内部控制线。
- 2) SIM 卡是否正确安装，请参考安装说明。
- 3) 检查 LED 指示灯状态，正常时，红色 WCDMA /GSM 状态指示灯慢闪（5 秒一次）；
- 4) 通过指令查询设备的参数，检查设备返回的参数是否正确。

9.2 平台显示离线状态

首先观察设备指示灯是否正常，在没有条件观察的情况下，可以先检查 SIM 卡的状态，步骤如下：

- 1) 拨打设备的 SIM 卡号码，看是否能听到电话接通的声音。
- 2) 车辆是否在无网络信号的地方。
- 3) 观察掉线设备所处的区域内，是个别设备掉线还是全部掉线，以判定是否为运营商网络问题。
- 4) SIM 卡是否欠费。
- 5) 如果设备在月底最后一天离线，请检查流量业务是否被取消。
- 6) 通过指令查询设备的参数，检查设备返回的参数是否正确。参见《操作指令》

9.3 长时间不定位

若设备 GPS 功能已被激活，但又长时间不定位，请检查设备：

- 1) 车辆是否在无 GPS 卫星信号的地方
- 2) 设备在安装时，应使接收面朝向天空。
- 3) 设备安装位置上方必须是没有电磁波吸收的

物质（如金属）遮挡的地方，特别要注意设备所处位置上方车辆玻璃不要贴防爆隔热膜（此膜成分中有较高的金属成分，会吸收高频电磁波），否则 GPS 信号会受到很大的影响导致定位精度下降，严重时会使设备难以定位。

9.4 定位漂移严重

当 GPS 信号接收环境较差时（周边有高大建筑遮挡 GPS 信号或者多云雷雨天气），会产生严重的定位漂移。此时请将车开到空旷的地方准确定位。

9.5 指令接收异常

- 1) 检查指令格式是否正确。
- 2) 车辆是否在无网络信号的地方。
- 3) 检查设备的 SIM 卡是否正确安装。

十、保修细则

10.1 特别声明

- 1) 若本产品日后有任何技术变更，恕不另行通知。
- 2) 产品外观、颜色如有改动，以实物为准。
- 3) 保修卡只适应于下述所列 IMEI 号机子的三包服务。
- 4) 请妥善保管保修卡，保修时请出示保修卡及原购买单据。

10.2 保修期

自购买之日起，非人为损坏故障主机保修一年。

10.3 售后服务

属下列情况之一的，不在保修范围，但可适当付费维修；

- (一) 超过保修期限。
- (二) 未经我司授权，擅自拆卸或维修造成损坏。
- (三) 因安装、使用、维护、保管不当造成损坏的。
- (四) 产品 IMEI 号被撕去或模糊不清。
- (五) 保修凭证与产品型号不符或保修凭证被涂改。
- (六) 因不可抗力造成的损坏。

Welcome to use our terminal , please read this manual carefully to install and operate the terminal exactly. This user manual is for reference only. If some contents and operation steps are inconsistent with those for the actual product, the latter will prevail.

Using TK119 GPS tracker, we can position, monitor and control the vehicle on the position server via GPS,WCDMA,GPRS and Internet. It can help customers to manage transparently, reduce cost, maintain security and raise efficiency. Now it is widely used in business traffic, logistics distribution, automobile lease, intelligent transportation, shipping market, army and police, rescuing, Safety Supervision and Intelligent city...

I. Product Features

- Supports WCDMA triple band ,GSM quad bands , universal in the world.
- Input Voltage: 7-36V DC.
- Located by GPS / LBS, support A-GPS
- GPS data uploaded by WCDMA/GPRS regularly, Web browser platform, Smart phone app and SMS query.
- ACC and vehicle status detection.
- Built-in battery, Power disconnect alarm & Low battery alarm.
- Built-in G-sensor ,Vibration, collision and falling alarm.
- GEO-fence alarm, speed & shift alarm.
- Remotely cut oil by Relay.
- Extend I/O port for extensional functions
- Multiple protocol support, OTA upgrade program.
- Water proof level IP67

Basic Specifications

Voltage	12 / 24 / 36 VDC
Work Current	<50mA@12V
Standby Current	<10mA@12V
GPS Accuracy	5-15m
LBS Accuracy	About 200m
GPS Frequency	1575MHz
GSM Frequency	850 / 900 / 1800 / 1900 MHz
WCDMA Frequency	W850 / W1900/ W2100 MHz
Hot/warm/cold Start	<3s, <15s, <60s
Battery Capacity	70mAh
Dimensions (mm)	87(L)X41.6(W)X 12(H)
Work Temperature	-20°C~70°C
Work Humidity	20%~80%RH
Net Weight	50 g

II. Components and Accessories

■ 2.1 Components

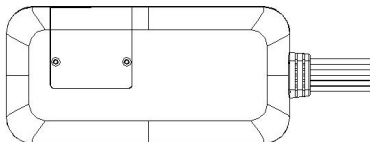

-Top Front-



-Bottom -

■ Accessories (reference pictures)



Power Cables (Fault)



Relay (Optional)

Relay for remotely cut off/resume oil, please note that the devices should be matched with accessories to realize these functions

III. SIM card Installation

Open packing case, check terminal is OK and the accessories are intact, or please contact your dealer;

You need a suitable SIM card for using the terminal, please contact your dealer if you have any question;

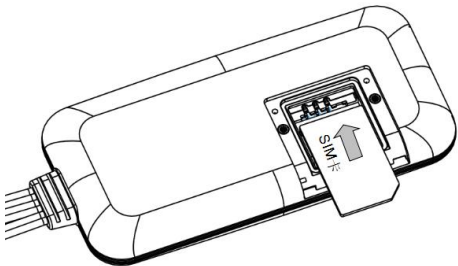

Insert SIM card to the device correctly

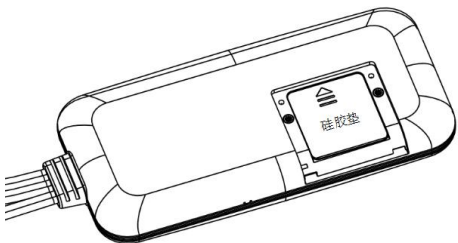

waterproof silicone must be put

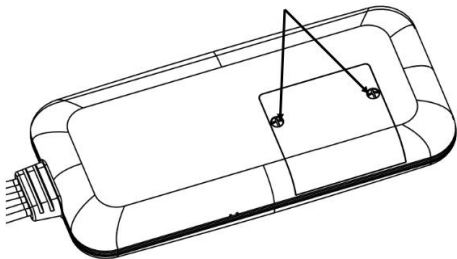

Tighten the screws after put the cover correctly

Note:

- Please cut off the power before installing or uninstalling the SIM card.
- The SIM card should have network to internet.
- SIM card should open Caller Identification function for telephone querying.
- If you enable the PIN code of the SIM card, please use your mobile phone to disable the PIN code.
- Please make sure that the SIM card has sufficient balance.

IV. Terminal Installation

4.1 Install the terminal

4.1.1 Please install the terminal concealed by professional person

Please make sure to install the terminal with this side upward, and use wide strong double-sided adhesive sponge to fix it.

Please make sure to install the terminal with this side towards the ground, and use wide strong double-sided adhesive sponge to fix it.

4.1.2 Installation Notice

- Hide the terminal properly inside the car body in order to avoid damages.
- Keep the terminal away from RF emission sources such as backing radar, car burglar alarm and other vehicle mounted communication devices.
- Suggest to use wide strong double-sided adhesive sponge to fix it, or use cable ties and other liable methods to fix it.
- Device Built-in WCDMA antenna and GPS antenna, Please ensure that signal receiving side is facing up(towards the sky) when doing installation,

without any metal material covered on the top. It may weaken signal and results in not work properly

The recommended installation location:

- 1) The hiding place below the front windshield trim panel;
- 2) The hiding place around the front dash (if the surface is not made of metal);
- 3) The place under the rear windshield;

4.2 Terminal wiring definition

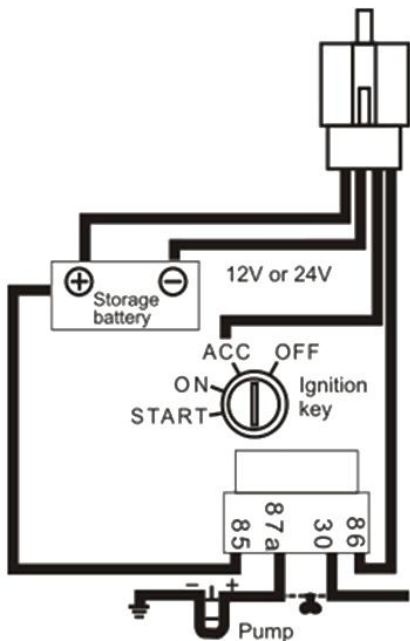

Total schematic wiring terminal

4.2.1 Power cables and other interface for remote control

The standard input voltage of the terminal is 7V-72VDC, so please choose the our original power cables, the red cable is positive and the black cable is negative; Please ground the positive pole separately or ground it to ground connection, not to any other ground.

Connect the ACC cable (orange cable) to ACC switch of the vehicle, then the position server can get the information about the vehicle power; the ACC cable can also be connected directly to the positive pole of the vehicle power, then the position server think that the vehicle is always ignited.

Connect the 4# cable (yellow cable) to the 86 terminal(with small yellow cable) of the relay. Use cable ties to fix the relay to waterproof place, or use plastic bags to cover the relay..

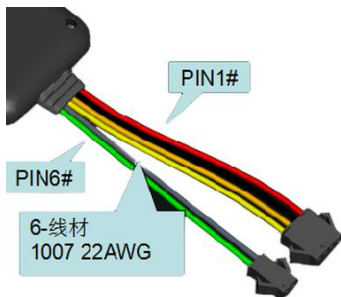

2P SM Male



5#	GPIO, 灰色	
6#	GPIO, 绿色	



1#	Power +, Red	
2#	Power -, Black	
3#	ACC, Orange	
4#	Relay, Yellow	

4.3 Relay wiring

Relay wiring diagram shows how to wire the relay to control the fuel pump:

4.3.1 Connect the 85 terminal (with small white cable) to the positive pole of the vehicle power (+12V/+24V), connect the 86 terminal (with small yellow cable) to the 4# cable of the terminal.

4.3.2 Cut off the positive pole of the fuel pump, next serial connect the positive pole to the 87a terminal (with thick green cable) of the relay, and connect another pole to 30 terminal (with thick green cable), showing as in the figure.



Bottom of the relay Wiring Diagram

Notice: Be sure that the voltage of the vehicle power should match up to the working voltage of the relay, or the relay will be damaged.

V. Power On / Off

5.1 Power on

Power on: insert a valid SIM card and wire all the cables, then the terminal power on itself.

5.2 LED Indicators

The red LED flickers fast when the terminal is searching for WCDMA network, it flickers

intermittently when the terminal has registered the WCDMA network successfully.

The blue LED flickers fast when the terminal is searching for the GPS satellite signal, it flickers intermittently when the terminal when the terminal has searched the satellites and can be positioned.

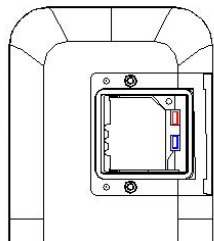

WCDMA/GSM LED

GPS LED

1. Red LED(indicates WCDMA/GSM working state)

Fast blinking	Searching for WCDMA/GSM network
Slow blinking	WCDMA/GSM works normally

2. Blue LED(indicates GPS signal state)

Fast blinking	Searching for GPS Satellites
Slow blinking	GPS works normally

5.3 Power off

Disconnect the external power and take off SIM card, after a while the terminal will shut down.

VI. Inquiry/Monitoring/Cut Oil

6.1 Inquiry by service platform

6.1.1 Web Browser platform

Login the service platform and enter your ID and password to check the position of the terminal. Please ask your dealer for the WWW address of the position service platform.

6.2.2 Smart phone applications

You can use a smart phone to check the terminal's position. We have prepare for you the Android client (Android), Apple clients (IOS), please check with your dealer to get installation package.

6.2 Inquiry by SMS

You can write a positioning SMS sending to the terminal to inquiry terminal position, the terminal will reply position SMS or map link. The SMS commands please refer to the Operation Commands

6.3 Cut Oil /Restore

6.3.1 Cut off oil circuits

The position server or the managers can send cut-off fuel commands when needed. The fuel of the vehicle will be cut off on the premise of safety, and the vehicle will not be powered on.

To make sure the safety of the vehicle, the fuel of the vehicle will be cut off only if the terminal has positioned by GPS and the speed of the vehicle is less than 20KM/h or the vehicle is not moving.

6.3.2 Recover oil circuits

The position server or the managers can send recover-fuel-circuit commands to the terminal when needed, the terminal will recover the fuel circuits of the vehicle.

VII. Terminal Alarm

7.1 Vibration Alarm

Conditions: When the Vehicle Vibration occurs.

Note: You need to set vibration sensitivity and time, there is an alarm switch.

7.2 Collision / falling Alarm

Conditions: When the Vehicle Collision or falling occurs.

7.3 Speed Alarm

Conditions: When the vehicle over and below the set speed.

Note: You need to set the low speed limit and high speed limit.

7.4 Shift Alarm

Conditions: When the vehicle occur the set shift in the Flameout state.

Note: Only valid in flameout state and vehicle occur the set shift distance.

7.5 Geo-fence Alarm

Conditions: when the vehicle entry / exit / across the Geo-fence.

Note: You need to set the conditions of crossing fence, fence types and so on.

7.6 Power disconnect Alarm

Conditions: When the device is disconnected from external Power.

7.7 Low battery Alarm

Conditions: When the device is disconnected from

external Power and built-in battery power falls below a certain value .

Note: When above alarm occurs, the terminal will send alarm to service platform, meanwhile send a SMS message to the administrator number if the number is set.

Note: Alarm parameters must be set before work in 7.1, 7.3, 7.4 & 7.5 , Please refer to the <**Operation Commands**>

VIII. Terminal Setting

Please refer to the <**Operation Commands**>

IX. Trouble shooting

9.1 Cannot connect platform

The terminal is never online on the position server when installed at the first time. Please check the terminal:

1) If the power cables are wired correctly? Pay attention to not connect them to the controlling

cables of the vehicle.

2) If the SIM card is installed correctly? Please refer to the installation instructions.

3) Check the status of the LED indicators. If the terminal is OK, the red LED and the blue LED will intermittently flick.

4) Inquiry the parameters of terminal via commands and check the accuracy of the parameters.

9.2 Offline status

First check if the LED indicators are OK, if cannot check them, you can check the SIM card following next steps:

1) call the SIM card of the terminal and check if you can hear the connecting ring.

2) Check if the vehicle is in the area where there is no WCDMA signal.

3) Check if one terminal or all terminals are offline in the area where terminal is offline. If all terminals are offline, you should ask the network operator if the network is OK.

- 4) Check if the SIM card has enough balance.
- 5) If the terminal becomes offline on the last day of one month, please check network is closed or not.
- 6) Inquiry the parameters of terminal via commands and check the accuracy of the parameters.

9.3 No positioned

If the GPS is active, but the terminal cannot be positioned for long time, please check the terminal:

- 1) If the vehicle is in the place where there is no GPS signal.
- 2) The upside of the terminal should be installed with face toward the sky.
- 3) The WCDMA and GPS signal may be weakened if the terminal is installed in the place with electromagnetic wave absorption material (such as metal blocks), special attention should be paid if there is metal thermal insulation layer or heating layer on the front windshield, so that the position accuracy will decline, and the severe ones will not be positioned.

9.4 Position drift

Serious position drift will be found in places where GPS signal is poor. Please drive the vehicle to the open places.

9.5 Commands receiving abnormally

- 1) Check the commands format.
- 2) Check if the vehicle is in the places where there is WCDMA signal.
- 3) Check if the SIM card is properly installed.

X. Warranty rules

10.1 Special statement

- 1) Technology change without notice.
- 2) If the color and appearance are inconsistent with those for the actual product, the latter will prevail.
- 3) Warranty card is only valid for the terminals with the following IMEI.
- 4) Please take care of the warranty card and show it with the original purchase receipts when enjoying the warranty service.

10.2 Warranty period

Since the date of purchase, passive waste host has one year warranty.

10.3 After sales

Any of the following circumstances not covered by the warranty, but may be appropriate to pay repair:

- 1) More than the warranty period.
- 2) Unauthorized removal or repair damaged.
- 3) Damage caused by improper installation, use, maintenance, custody.
- 4) The IMEI label is torn or Obscure.
- 5) Warranty certificate and product models do not match or warranty certificate be altered.
- 6) Damage caused by force majeure.

Warranty Card/保修卡

NAME/姓名 _____

TEL/电话 _____

Address/地址 _____

Model/机型 _____

IMEI Number (IMEI 号)



Selling Unit/经销商 _____

Purchase Date / 购买日期

_____YY/年_____MM/月_____DD/日

Maintenance records / 维修记录

Date 日期	Description 故障描述	Records 维修记录	Completion Date 完成日期	Engineer 维修人员