

**TOP LED:5050OBRIR
(5050SMD 840nm+630nm+460nm LED)**



 **ATTENTION**
OBSERVE PRECAUTIONS
ELECTROSTATIC
SENSITIVE DEVICES



CUSTOMER APPROVED SIGNATURES	SALES APPROVED	APPROVED BY	CHECKED BY	PREPARED BY

1. Features

- Color :840nm+630nm+460nm
- Chips Size:300um(IR)、 250um(R)、 300um(B)
- Lens: water clear
- EIA STD Package
- Meet ROHS, Green Product
- Compatible With SMT Automatic Equipment
- Compatible With Infrared Reflow Solder And Wave Solder Process

2. Package Profile & Soldering PAD Suggested

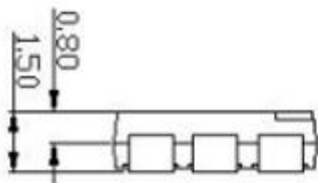
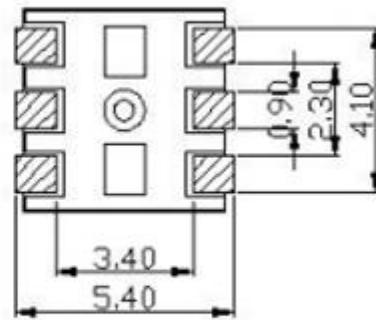
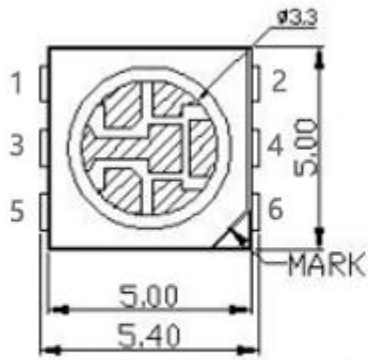

RECOMMENDED PCB SOLDER PAD:

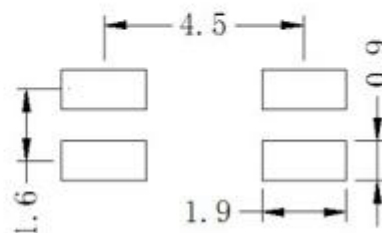
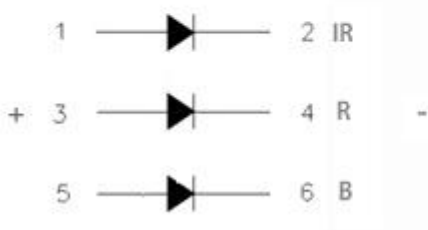

- Notes: 1. All dimensions are in millimeters ;
2. Tolerance is ± 0.10 mm unless otherwise noted.

3. Soldering Profile Suggested

	Reflow Soldering		Hand Soldering	
	Lead Solder	Lead-free Solder	Temperature	Soldering time
Pre-heat	120 ~ 150°C	180 ~ 200°C	350°C Max.	3 sec. Max.
Pre-heat time	120 sec. Max.	120 sec. Max.		(one time only)
Peak temperature	240°C Max.	260°C Max.		
Soldering time	10 sec. Max.	10 sec. Max.		
Condition	refer to Temperature - profile ①.	refer to Temperature - profile ②. (N ₂ reflow is recommended.)		

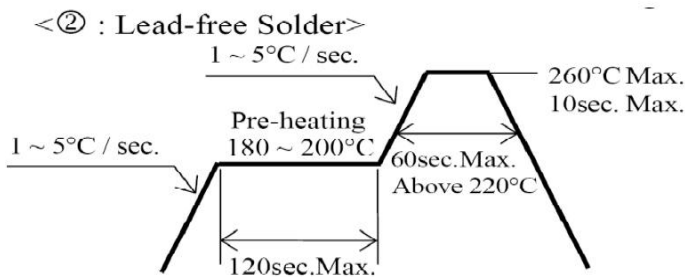
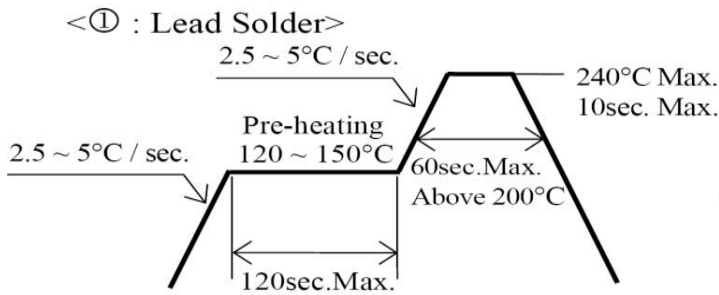



4. Absolute Maximum Ratings At Ta=25°C

Parameter	Symbol	Absolute maximum Rating			Unit
		840nm	630nm	460nm	
Power Dissipation	Pd	30	50	75	mW
Peak Forward Current (1/10 Duty Cycle, 0.1ms Pulse Width)	IFP	300	100	100	mA
DC Forward Current	IF	20	20	20	mA
Reverse Voltage	VR	5			V
Operating Temperature Range	Topr	-25°C ~ +80°C			
Storage Temperature Range	Tstg	-40°C ~ +80°C			
Soldering Condition	Tsol	Reflow soldering : 260°C For 5 Seconds Hand soldering: 300°C For 3 Seconds			
Packing	pcs	1000per reel			

5. Electrical Optical Characteristics At Ta=25°C

Parameter		Symbol	Min.	Typ.	Max.	Unit	Test Condition
Luminous Intensity	840nm	IV	10		20	mw/sr	IF=20mA
	630nm		500	600	700	mcd	
	460nm		450		600		
Forward Voltage	840nm	VF	1.3		1.6	V	IF=20mA
	630nm		1.9	2.2	2.4		
	460nm		2.8	3.0	3.4		
Peak Wavelength	840nm	λ_p	845	850	860	nm	IF=20mA
	630nm		628	633	635		
	460nm		455	460	463		
Viewing Angle		2 θ 1/2		120		deg	IF=20mA
Reverse Current		IR			5	uA	VR=5V

- Notes: 1. Luminous intensity is measured with a light sensor and filter combination that approximates the CIE eye-response curve.
2. θ 1/2 is the off-axis angle at which the luminous intensity is half the axial luminous intensity.
3. The dominant wavelength, λ_d is derived from the CIE chromaticity diagram and represents the single wavelength which defines the color of the device.

6. Tape Leader & Trailer Dimensions And Reel

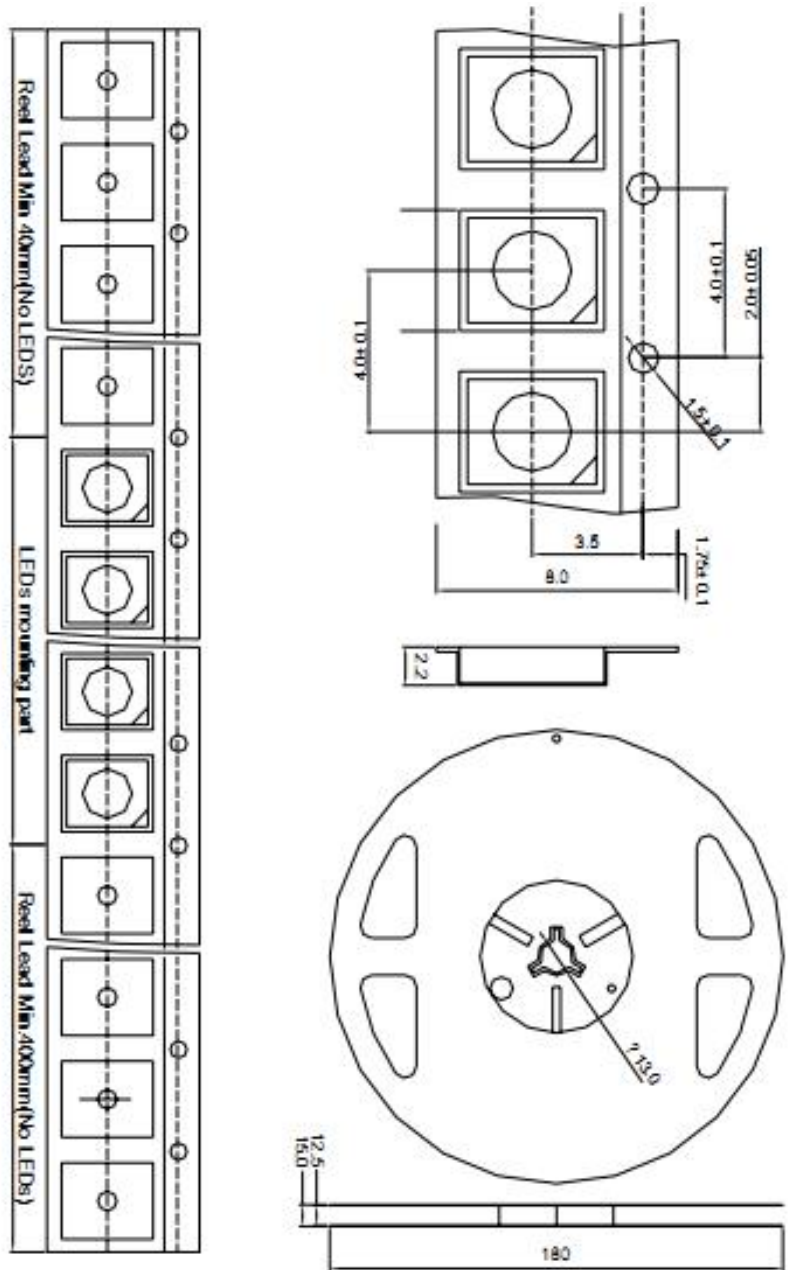

Dimensions are specified as follows:mm

Notes:

- 1) The packing only appropriate for Mingjia light.
- 2) Normal packing quantity: 1,000pcs/reel

7. Reliability Test

Classification	Test Item	Test Condition	Reference Standard	Reference Standard
Endurance Test	Operation Life	Ta= Under Room Temperature As Per Data Sheet Maximum Rating	1000HRS (-24HRS,+72HRS)*@20mA	MIL-STD-750D:1026 MIL-STD-883D:1005 JIS C 7021:B-1
	High Temperature, High Humidity Storage	IR-Reflow In-Board, 2 Times Ta= 65±5°C,RH= 90~95%	240HRS±2HRS	MIL-STD-202F:103B JIS C 7021:B-11
	High Temperature Storage	Ta= 105±5°C	1000HRS (-24HRS,+72HRS)	MIL-STD-883D:1008 JIS C 7021:B-10
	Low Temperature Storage	Ta= -55±5°C	1000HRS (-24HRS,+72HRS)	JIS C 7021:B-12
Environmental Test	Temperature Cycling	105°C ~ 25°C ~ -55°C ~ 25°C 30mins 5mins 30mins	10 Cycles	MIL-STD-202F:107D MIL-STD-750D:1051 MIL-STD-883D:1010 JIS C 7021:A-4
	Thermal Shock	IR-Reflow In-Board, 2 Times 85 ± 5°C ~ -40°C ± 5°C 10mins 10mins	10 Cycles	MIL-STD-202F:107D MIL-STD-750D:1051 MIL-STD-883D:1011
	Solder Resistance	T.sol= 260 ± 5°C	10 ± 1secs	MIL-STD-202F:210A MIL-STD-750D:2031 JIS C 7021:A-1
	IR-Reflow Normal Process	Ramp-up rate(183°C to Peak) +3°C / second max Temp. maintain at 125(±25)°C 120 seconds max Temp. maintain above 183°C 60-150 seconds Peak temperature range 235°C+5/-0°C Time within 5°C of actual Peak Temperature (tp) 10-30 seconds Ramp-down rate +6°C/second max	----	MIL-STD-750D:2031.2 J-STD-020C
	IR-Reflow Pb Free Process	Ramp-up rate(217°C to Peak) +3°C / second max Temp. maintain at 175(±25)°C 180 seconds max Temp. maintain above 217°C 60-150 seconds Peak temperature range 260°C+0/-5°C Time within 5°C of actual Peak Temperature (tp) 20-40 seconds Ramp-down rate +6°C/second max	----	MIL-STD-750D:2031.2 J-STD-020C
Solderability	T.sol= 235 ± 5°C Immersion rate 25±2.5 mm/sec Coverage ≥95% of the dipped surface	Immersion time 2±0.5 sec	MIL-STD-202F:208D MIL-STD-750D:2026 MIL-STD-883D:2003 IEC 68 Part 2-20 JIS C 7021:A-2	

8. SMD LED Technical Data

Reflow soldering profile for LEAD-FREE SMD process

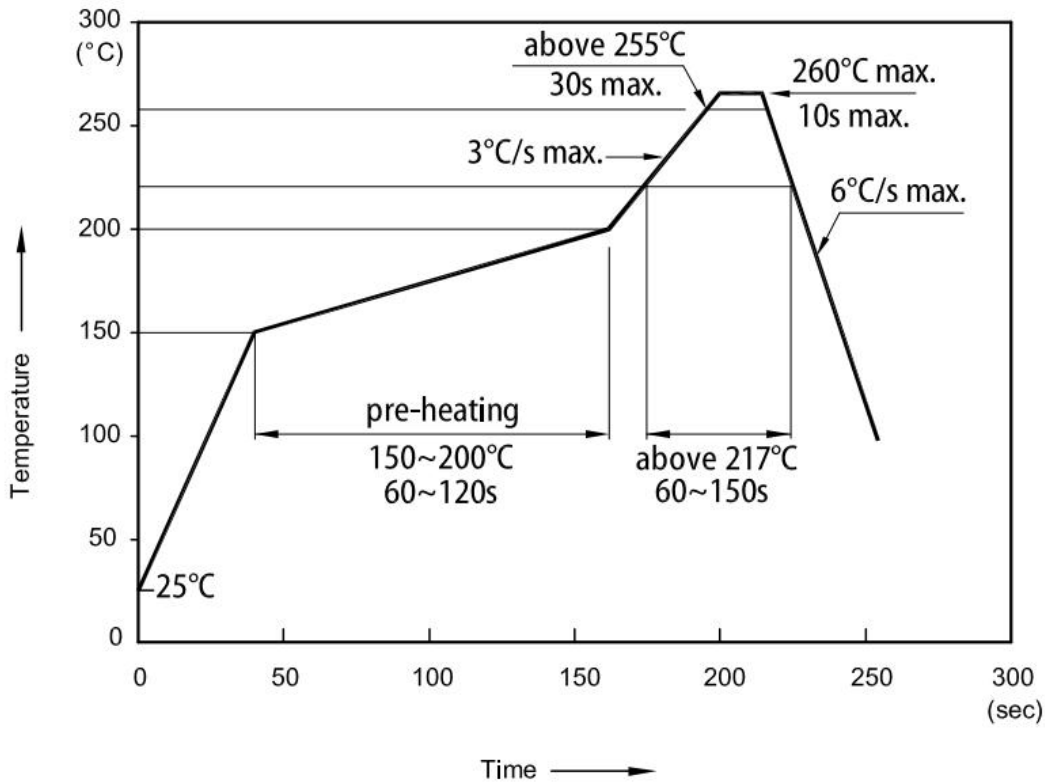

Notes:

1. Don't cause stress to the LEDs while it is exposed to high temperature.
2. The maximum number of reflow soldering passes is 2 times
3. Reflow soldering is recommended. Other soldering methods are not recommended as they might cause damage to the product

HANDLING PRECAUTIONS

Compare to epoxy encapsulant that is hard and brittle, silicone is softer and flexible. Although its characteristic significantly reduces thermal stress, it is more susceptible to damage by external mechanical force. As a result, special handling precautions need to be observed during assembly using silicone encapsulated LED products. Failure to comply might lead to damage and premature failure of the LED.

1. Handle the component along the side surfaces by using forceps or appropriate tools.



2. Do not directly touch or handle the silicone lens surface. It may damage the internal circuitry.

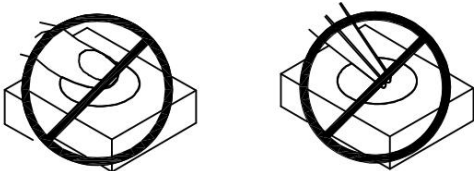

3. Do not stack together assembled PCBS containing exposed LEDs. Impact may scratch the silicone lens or damage the internal circuitry.



4. 4-A The inner diameter of the SMD pickup nozzle should not exceed the size of the LED to prevent air leaks

4-B A pliable material is suggested for the nozzle tip to avoid scratching or damaging the LED surface during pickup

4-C The dimensions of the component must be accurately programmed in the pick-and-place machine to insure precise pickup and avoid damage during production

4-D As silicone encapsulation is permeable to gases, some corrosive substances such as H₂S might corrode silver plating of leadframe. Special care should be taken if an LED with Silicone encapsulation is to be used near such substances.

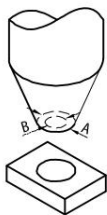

5. Avoid continued exposure to the condensing moisture environment and keep the product away from rapid transitions in ambient temperature.

6. Product in the original sealed package is recommended to be assembled within 24 hours of opening.