



SHENZHEN BYT OPTO-ELECTRONIC CO., LTD.

Part Number:U5293IRC-14L/94I100

## 1. Features 产品特征

- High reliability 高可靠性
- 2.54mm lead spacing 2.54毫米引脚间距
- Low forward voltage 低正向电压
- Good spectral matching to Si photodetector 良好的光谱匹配Si光电探测器
- High radiant intensity 高辐射强度
- Pb free 无铅
- The product itself will remain within RoHS compliant version.  
该产品将一直符合RoHS规范

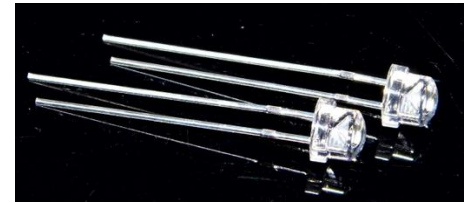

## 2. Descriptions 产品描述

The device is spectrally matched with phototransistor, photodiode and infrared receive module 。该设备是光谱与光电晶体管，光电二极管相匹配和红外线接收模块

## 3. Applications 适用范围

- **Free air transmission system** 自由的空气传输系统
- **Optoelectronic switch** 光电开关
- **Floppy disk drive** 软盘驱动器
- **Infrared applied system** 红外应用系统
- **Smoke detector** 烟雾探测器



SHENZHEN BYT OPTO-ELECTRONIC CO., LTD.

Part Number:U5293IRC-14L/94I100

#### 4. Device Selection Guide 产品指南

LED Part No	Chip	Lens Color胶体颜色
	Material	
IR	GaAlAs	Water clear

#### 5. Package Dimensions 外形尺寸

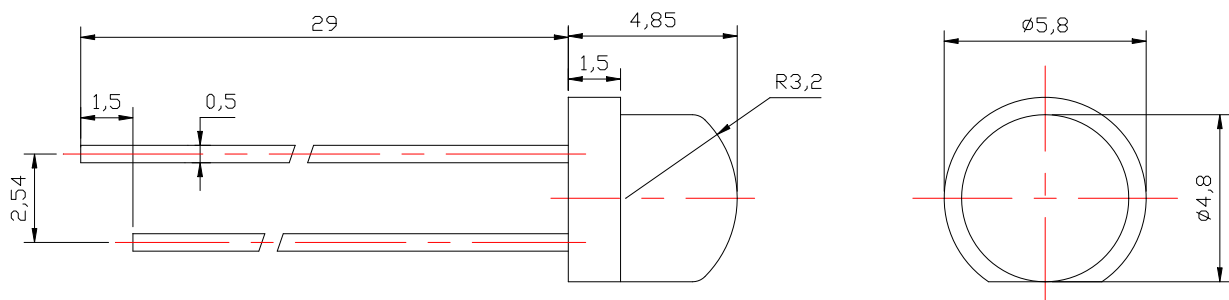

#### Notes:

**1. All dimension units are millimeters.**

以上尺寸单位为 mm.

**2. All dimension tolerance is  $\pm 0.2$ mm unless otherwise noted.**

以上尺寸平均误差  $\pm 0.2$ mm.

**3. An epoxy meniscus may extend about 1.5mm down the leads.**

胶体底部爬胶尺寸不超过 1.5mm.

**4. Burr around bottom of epoxy may be 0.5mm max.**

胶体尺寸最大误差  $\pm 0.5$ mm.



SHENZHEN BYT OPTO-ELECTRONIC CO., LTD.

Part Number:U5293IRC-14L/94I100

### 6. Absolute Maximum Ratings At Ta=25°C 极限参数

Parameter参数	Symbol 符号	Rating 范围	Unit 单位
Power Dissipation at (or below)25°C Free Air Temperature 25 °C空气温度极限功耗	Pd	180	mW
Peak Forward Current 峰值正向工作电流 (1/10 Duty Cycle, 0.1ms Pulse Width) 脉冲驱动时极限正向电流0.1MS脉冲宽度	IFP	1	A
Continuous Forward Current 连续正向电流	IF	100	mA
Reverse Voltage 反向冲击电压	VR	5	V
Operating Temperature Range 正常使用温度	Topr	-25°C ~ +80°C	
Storage Temperature Range 贮藏温度	Tstg	-40°C ~ +80°C	
Soldering Condition 可焊接温度	Tsol	Reflow soldering : 260°C For 3 Seconds	
Electro-Static-Discharge(HBM)	ESD	1000V	
Service life under normal conditions 正常使用条件下寿命	Time	80000h	
Service life under normal conditions 正常使用条件下质保	Time	2 years	
Packing (包装)	pcs	1000per reel	



**7. Electrical Optical Characteristics At Ta=25°C 光电特性**

Parameter	Symbol	Min.	Typ.	Max.	Unit	Condition
Radiant Intensity 辐射强度	Ee	5	---	12	mW/sr	IF=20mA
		20	--	40		IF=100mA
		---	196	---		IF=1A Pulse Width≤100us Duty≤1%
Radiant Power 辐射功率	Po	3.0	---	---	mw	IF=100mA
Viewing Angle 发光角度	2θ1/2	---	120	---	deg	IF=100mA
Peak Wavelength 峰值波长	λp	---	940	---	nm	IF=100mA
Spectral Width of Half Value 光谱带宽	Δλ	---	42	---	nm	IF=100mA
Forward Voltage 正向电压降	VF	1.1	1.2	1.5	V	IF=20mA
		---	1.3	1.8		IF=100mA
		---	3	4		IF=1A Pulse Width≤100us Duty≤1%
Reverse Current 反向电流	IR	---	---	5	uA	VR=5V
Optical Rise Time 光学上升时间	TR	---	25	35	ns	IF=100mA
Optical Fall Time 光学下降时间	TF	---	15	35	ns	IF=100mA

Notes: 1. Luminous intensity is measured with a light sensor and filter combination that approximates the CIE eye-response curve.

发光强度是衡量一个光线感应器和过滤器的组合，接近CIE人眼反应曲线

2. θ1/2 is the off-axis angle at which the luminous intensity is half the axial luminous intensity.

1/2是离轴角度的限制，发光强度的一半轴向发光强度

3. The dominant wavelength, λd is derived from the CIE chromaticity diagram and represents the single wavelength which defines the color of the device.

主波长λd被从CIE色度图，代表了单一波长的定义设备的颜色。



### 8. Typical Electrical-Optical Characteristics Curves 光电特性曲线

Fig.1 Forward Current vs. Ambient Temperature

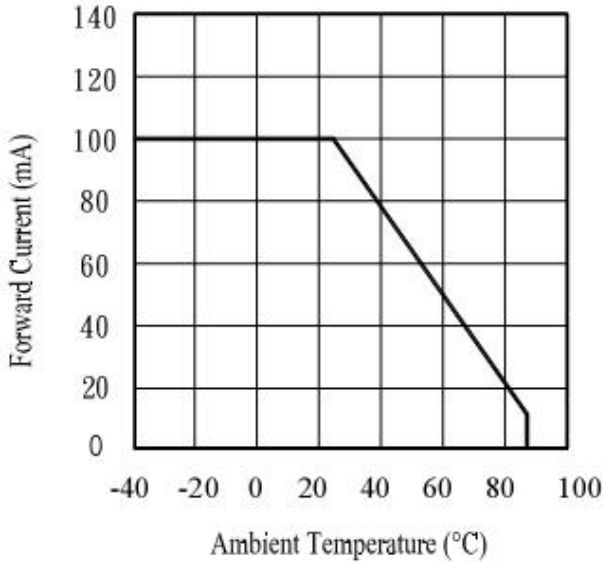

Fig.2 Spectral Distribution

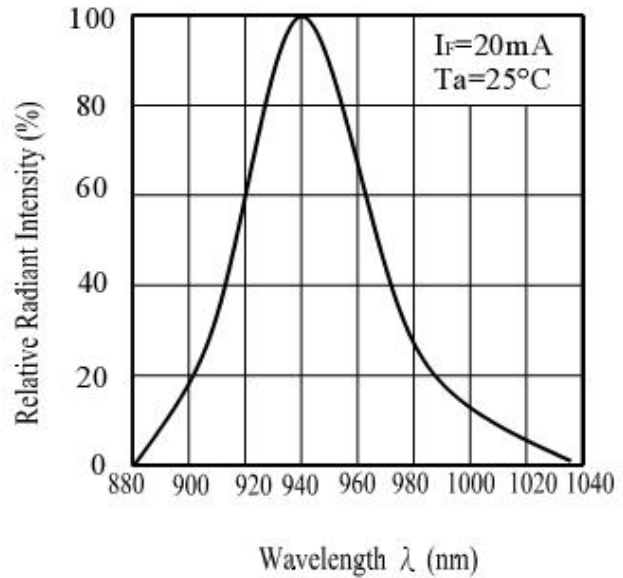

Fig.3 Peak Emission Wavelength vs. Ambient Temperature

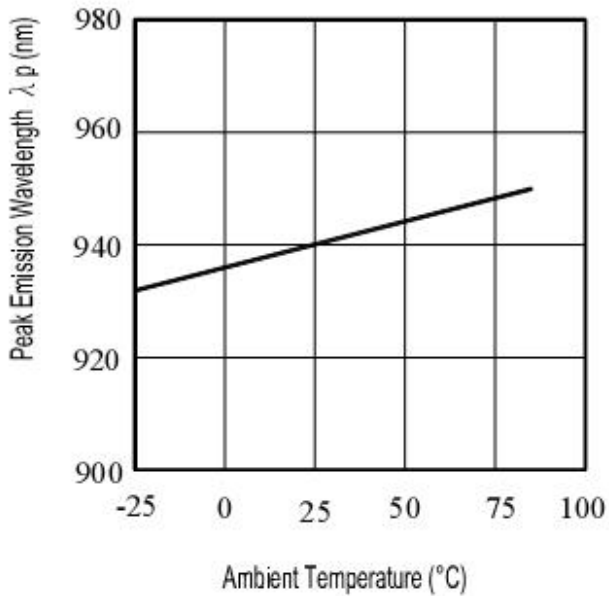
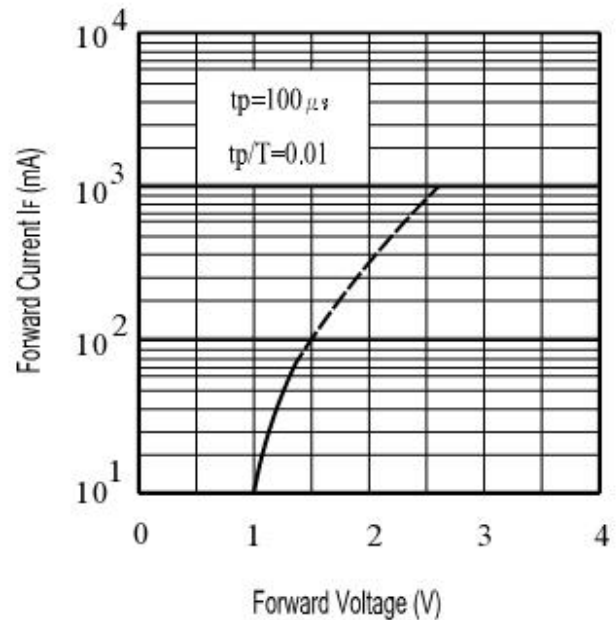

Fig.4 Forward Current vs. Forward Voltage





### 8. Typical Electrical-Optical Characteristics Curves

Fig.5 Relative Intensity vs. Forward Current

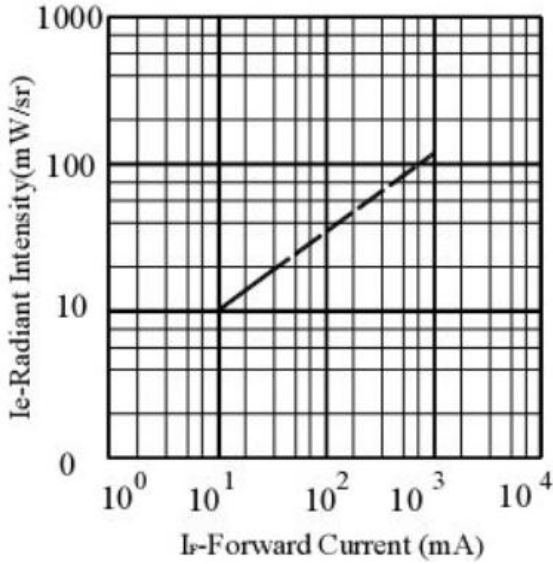

Fig.6 Relative Radiant Intensity vs. Angular Displacement

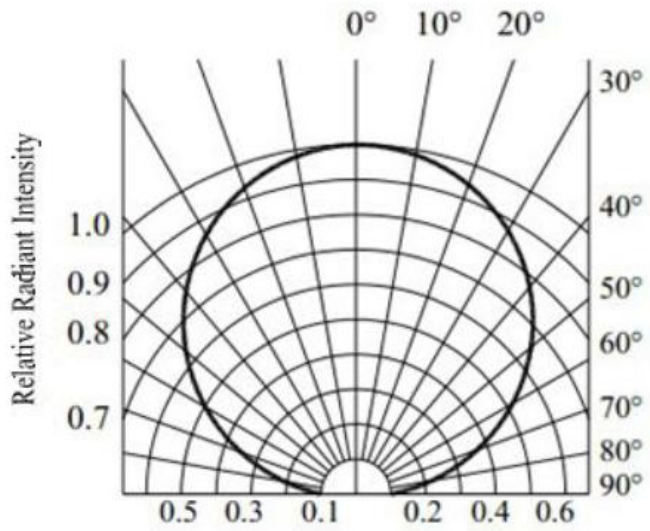

Fig.7 Relative Intensity vs. Ambient Temperature(°C)

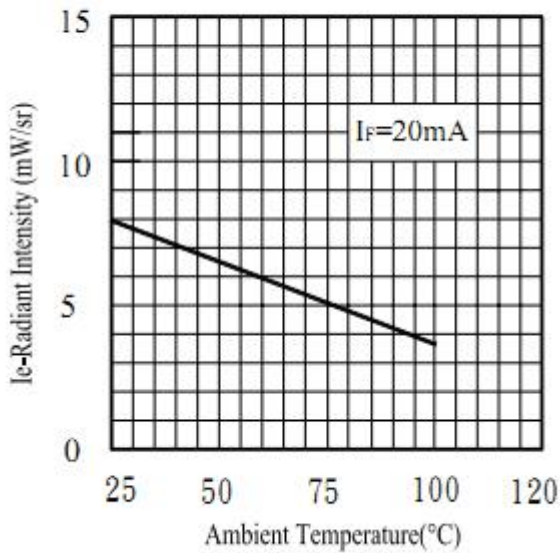
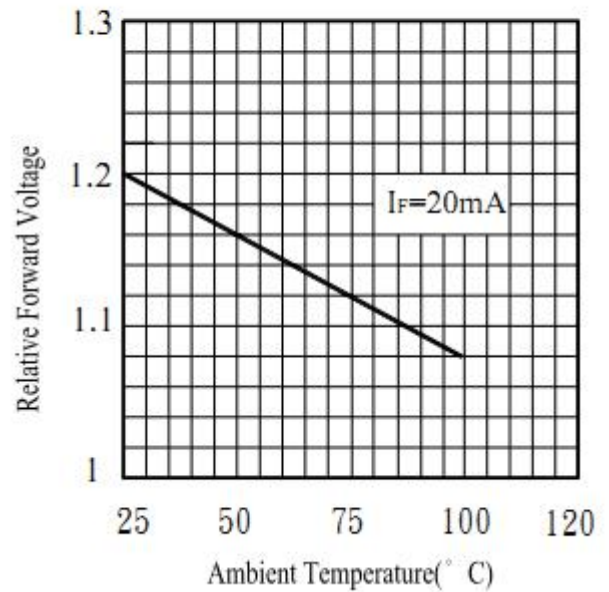

Fig.8 Forward Voltage vs. Ambient Temperature(°C)





**9. Reliability Test 可靠性测试**

Classification 分类	Test Item 测试项目	Test Condition 测试条件	Reference Standard 参考标准	Reference Standard
Endurance Test 耐力测试	Operation Life 寿命	Ta= Under Room Temperature As Per Data Sheet Maximum Rating	1000HRS (-24HRS,+72HRS)*@20mA	MIL-STD-750D:1026 MIL-STD-883D:1005 JIS C 7021:B-1
	High Temperature ,High Humidity Storage 高温高湿度存储	IR-Reflow In-Board, 2 Times Ta= 65±5°C,RH= 90~95%	240HRS±2HRS	MIL-STD-202F:103B JIS C 7021:B-11
	High Temperature Storage 高温储存	Ta= 105±5°C	1000HRS (-24HRS,+72HRS)	MIL-STD-883D:1008 JIS C 7021:B-10
	Low Temperature Storage 低温储存	Ta= -55±5°C	1000HRS (-24HRS,+72H RS)	JIS C 7021:B-12
Environmental Test 环境的试验 温度	Temperature Cycling 温度周期	105°C ~ 25°C ~ -55°C ~ 25°C 30mins 5mins 30mins	10 Cycles	MIL-STD-202F:107D MIL-STD-750D:1051 MIL-STD-883D:1010 JIS C 7021:A-4
	Thermal Shock 高低温测试	IR-Reflow In-Board, 2 Times 85 ± 5°C ~ -40°C ± 5°C 10mins 10mins	10 Cycles	MIL-STD-202F:107D MIL-STD-750D:1051 MIL-STD-883D:1011
	Solder Resistance 焊锡性	T.sol= 260 ± 5°C	10 ± 1secs	MIL-STD-202F:210A MIL-STD-750D:2031 JIS C 7021:A-1
	IR-Reflow Normal Process 红外回流焊 正常流程	Ramp-up rate(183°C to Peak) +3°C / second max Temp. maintain at 125(±25)°C 120 seconds max Temp. maintain above 183°C 60-150 seconds Peak temperature range 235°C+5/-0°C Time within 5°C of actual Peak Temperature (tp) 10-30 seconds Ramp-down rate +6°C/second max	---	MIL-STD-750D:2031.2 J-STD-020C
	IR-Reflow Pb Free Process 红外回流焊 无铅制程	Ramp-up rate(217°C to Peak) +3°C / second max Temp. maintain at 175(±25)°C 180 seconds max Temp. maintain above 217°C 60-150 seconds Peak temperature range 260°C+0/-5°C Time within 5°C of actual Peak Temperature (tp) 20-40 seconds Ramp-down rate +6°C/second max	---	MIL-STD-750D:2031.2 J-STD-020C
Solderability 可焊性	T.sol= 235 ± 5°C Immersion rate 25±2.5 mm/sec Coverage ≥95% of the dipped surface	Immersion time 2±0.5 sec	MIL-STD-202F:208D MIL-STD-750D:2026 MIL-STD-883D:2003 IEC 68 Part 2-20 JIS C 7021:A-2	



## 10. Cautions 注意事项

### Application 应用

1. A LED is a current-operated device. The slight shift of voltage will cause big change of current, which will damage LEDs. Customer should use resistors in series for the Over-Current-Proof.

A LED是电流驱动的器件。电压的微小变化将引起电流的很大变化，这将损坏的LED。客户应尽量使用串联电阻的过电流电路（恒流驱动）

2. In order to ensure intensity uniformity on multiple LEDs connected in parallel in an application, it is recommended to use individual resistor separately, as shown in Circuit A below. The brightness of each LED shown in Circuit B might appear difference due to the differences in the I-V characteristics of those LEDs. 为了确保对并联连接在一个应用程序的多个LED亮度的均匀性，它是建议单独使用单独的电阻，如下图所示电路A。每个的亮度在电路B所示的LED可能会出现差异，由于这些的IV特性的差异LED指示灯。

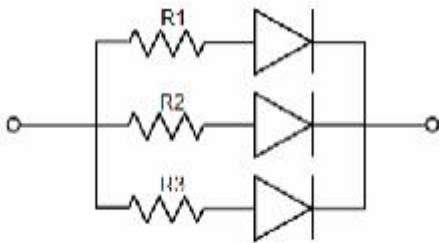

Circuit model A

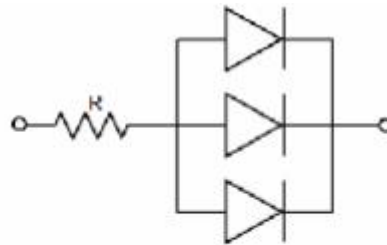

Circuit model B

3. High temperature may reduce LEDs' intensity and other performances, so keeping it away from heat source to get good performance is necessary.

高温可能会降低LED的强度和其它性能，因此必须让它远离热源以保持其良好的性能

### Storage 存储

1. Before opening original package, it is recommended to store them in the following environment:

在未打开原装包时，建议将它们存储在以下环境中：

Temperature: 5°C~30°C

Humidity: 85%RH max.

2. After opening original package, the storage ambient for the LEDs should be in 5~30°C temperature and 60% or less relative humidity.

打开原包装后，LED应保存在5~30°C的温度和60%或更低的相对湿度的环境中。

3. In order to avoid moisture absorption, it is recommended that the LEDs that out of the original package should be stored in a sealed container with appropriate desiccant, or in desiccators with nitrogen ambient.

为了避免水分的吸收，建议LED灯拿出原包后应储存在密闭容器中并放适当的干燥剂，或在氮气环境的干燥器中

4. The LEDs should be used within 168hrs (7 days) after opening the package. Once been mounted, soldering should be quick.

该LED应在打开包装后168小时（7天）之内使用。一旦被安装，应尽快焊接





5. If the moisture absorbent material (silica gel) has faded away or the LEDs stored out of original package for more than 168hrs (7 days), baking treatment should be performed using the conditions:  
60°C at least 24 hours.

如果吸湿材料（硅胶）已消失或LED暴露在外的时间超过超过168小时（7天）时，使用或包装前请进行以下烘烤处理：60 °C至少烤24小时。

#### **ESD (Electrostatic Discharge )-Protection ESD（静电放电）保护**

A LED (especially the Blue、White and Green product) is an ESD sensitive component, and static electricity or power surge will damage the LED. ESD-damaged LEDs will exhibit abnormal characteristics such as high reverse leakage current, low forward voltage, or "no light-up" at low currents, etc.

Some advice as below should be noticed:

A LED（特别是兰、白、绿LED）是一个ESD敏感元件，和静电或电力激增会损坏LED。静电放电破坏的LED将展出如高反向漏电流，低正向电压，或“不亮灯”在低电流等异常特征。应注意以下一些建议：

1. A conductive wrist strap or anti-electrostatic glove should be worn when handling these LEDs.  
作业员必须佩戴静电环、防静电手套、穿防静电服
2. All devices, equipment, machinery, work tables and storage racks, etc. must be properly grounded.  
所有器件，设备，机器，工作桌和储存架等必须正确接地
3. Use anti-static package or boxes to carry and storage LEDs. And ordinary plastic package or boxes is forbidden to use.  
使用防静电包装盒或携带和储存的LED。不允许使用普通的塑料包或箱子
5. Use ionizer to neutralize the static charge during handling or operating.  
使用离子发生器处理或操作过程中和静电
6. All surfaces and objects within 1 ft close to LEDs measure less than 100V.  
1英尺内的接近LED的所有表面和物体测量小于100V

#### **Cleaning清洁**

Use alcohol-based cleaning solvents such as IPA (isopropyl alcohol) to clean LEDs if necessary.

禁止使用不明化学液体擦拭发光管器件，以免导致伤害材料。如果一定要擦拭材料，建议使用使用含酒精的清洁剂，如IPA（异丙醇）

#### **Soldering焊接**

1. Reflow soldering should not be done more than 2 times.  
回流焊不应该做2次以上
2. Manual soldering is only suggested on repair and rework. The maximum soldering temperature should not exceed 260°C within 3 sec. And the maximum capacity of soldering iron is 30W in power.  
手工焊接只建议在维修和返工。烙铁的最大容量是功率30W，焊接温度要求不高于260°C不应超过3秒内
3. During the soldering process, do not touch the lens at high temperature.  
在焊接过程中，不要在高温下接触到胶体



SHENZHEN BYT OPTO-ELECTRONIC CO., LTD.

Part Number:U5293IRC-14L/94I100

4. After soldering, any mechanical force on the lens or any excessive vibration shall not be accepted to apply, also the circuit board shall not be bent as well.

焊接后，过大的机械力使用在胶体上或整体灯珠受到过度振动的，不予受理投诉，同时引脚最好不要弯曲

#### Others 其他说明

1. The LEDs described here are intended to be used for ordinary electronic equipment (such as office equipment, communication equipment and household applications). Consult BYT's Sales in advance for the applications in which exceptional reliability is required, particularly when the failure or malfunction of the LEDs may directly jeopardize life or health. (such as in aviation, transportation, traffic control equipment, medical and life support systems and safety devices).

这里所描述的LED灯的本意是用于普通的电子设备（如办公设备，通讯设备和家用应用程序）。当LED的失效或故障可能直接危及生命或健康时请提前咨询百优特光电销售其可靠性。（如航空，交通运输，交通控制设备，医疗和生命支持系统和安全装置）。

2. The light output from the high luminous intensity LEDs may cause injury to human eyes when viewed directly. 正面看从高发光强度LED的光输出时可能会造成伤害人的眼睛
3. The appearance and specifications of the product may be modified for improvement without prior notice. 该产品的外观和规格可能会被修改，恕不另行通知。