

TOP LED:3528FIRC-97L14I100 (3528SMD LED - IR LED)



	<p>ATTENTION OBSERVE PRECAUTIONS ELECTROSTATIC SENSITIVE DEVICES</p>
-------------------------------------------------------------------------------------	-----------------------------------------------------------------------------------------



CUSTOMER APPROVED SIGNATURES	SALES APPROVED	APPROVED BY	CHECKED BY	PREPARED BY

1. Features

- Color :975nm IR LED
- LED Material:AlGaAs/Si LED Chips
- Number of chips:One Chip
- LED Size:355*355um
- Lens: Water clear
- EIA STD Package
- Meet ROHS, Green Product
- Compatible With SMT Automatic Equipment
- Compatible With Infrared Reflow Solder And Wave Solder Process

2. Package Profile & Soldering PAD Suggested

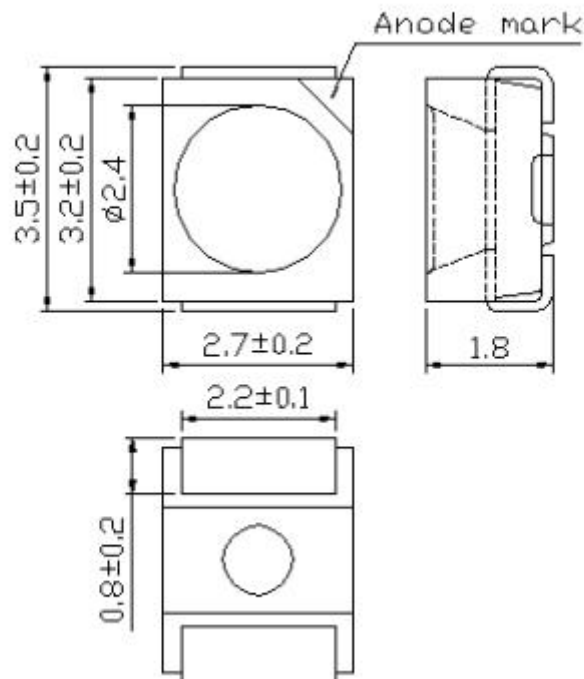

- Notes:
1. All dimensions are in millimeters ;
 2. Tolerance is ± 0.10 mm unless otherwise noted.



3. Absolute Maximum Ratings At Ta=25°C

Parameter	Symbol	Rating	Unit
Power Dissipation	Pd	300	mW
Pulse Forward Current	IFP	500	mA
Forward Current	IF	150	mA
Reverse Voltage	VR	5	V
Junction Temperature	Tj	115	°C
Operating Temperature	Topr	-40 ~ +80	°C
Storage Temperature Range	Tstg	-40 ~ +100	°C
Soldering Temperature	Tsol	260	°C
Electro-Static-Discharge(HBM)	ESD	2000	V
Antistatic bag	Piece	2000	Bag

4. Electrical Optical Characteristics At Ta=25°C

Parameter	Symbol	Min	Typ	Max	Unit	Test Condition
Forward Voltage	VF	1.1	1.2	1.4	V	IF=20mA
		1.2	1.3	1.5		IF=50mA
		1.3	1.4	1.5		IF=100mA
		1.4	1.5	1.8		IF=150mA
Radiant Intensity	IE	3		8	mW/sr	IF=20mA
		15		20		IF=50mA
		28		40		IF=100mA
		40		60		IF=150mA
Peak Wavelength	λ_P	970	975	980	nm	IF=100mA
Half Width	$\Delta\lambda$		45		nm	IF=100mA
Viewing Half Angle	$2\theta_{1/2}$		± 62		deg	IF=100mA
Reverse Current	IR			5	μA	VR=5V
Rise Time	tr		15		ns	IF=100mA
Fall Time	tf		6		ns	IF=100mA

- Notes: 1. Luminous intensity is measured with a light sensor and filter combination that approximates the CIE eye-response curve.
2. $\theta_{1/2}$ is the off-axis angle at which the luminous intensity is half the axial luminous intensity.
3. The dominant wavelength, λ_d is derived from the CIE chromaticity diagram and represents the single wavelength which defines the color of the device.

5. Typical Electrical-Optical Characteristics Curves

Forward Current - Forward Voltage

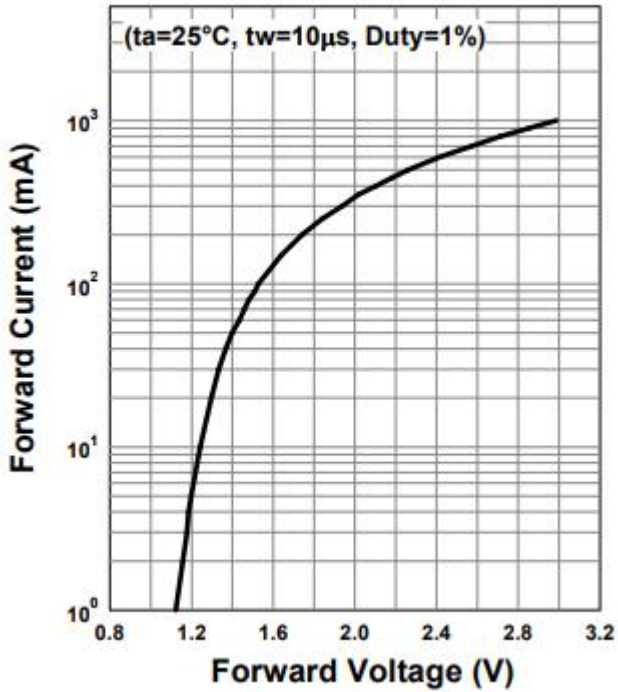

Relative Radiant Intensity - Forward Current

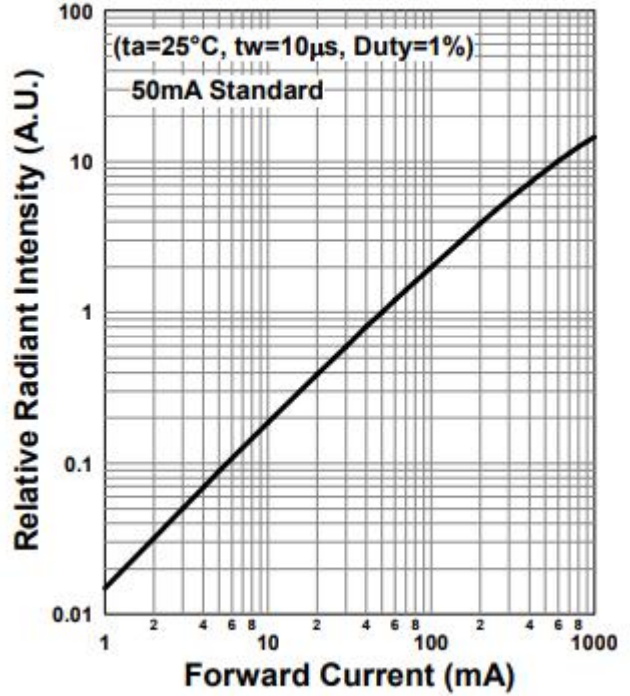

Forward Current - Pulse Duration

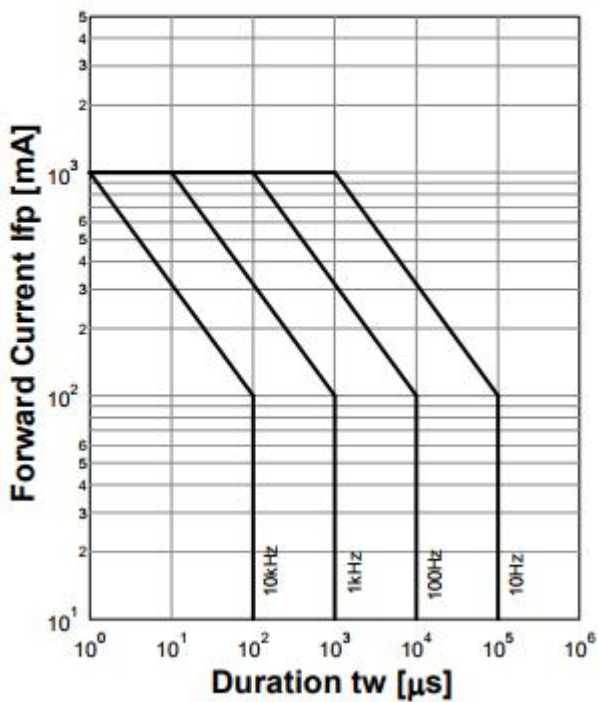

Allowable Forward Current - Ambient Temperature

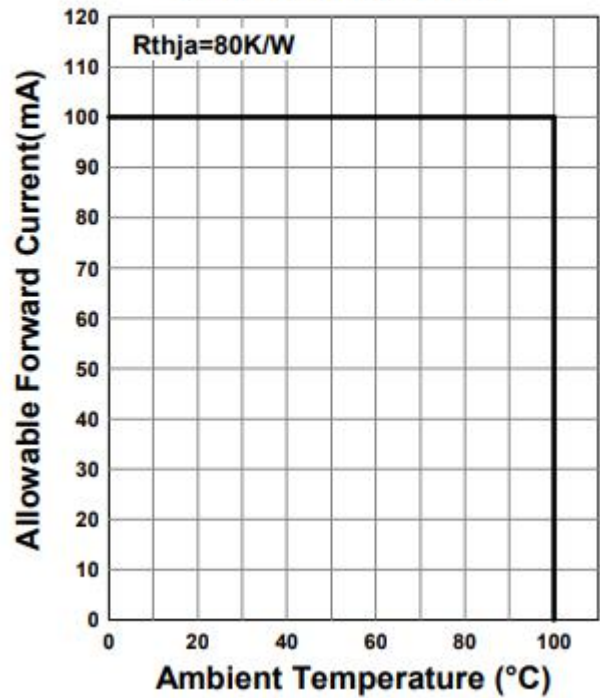

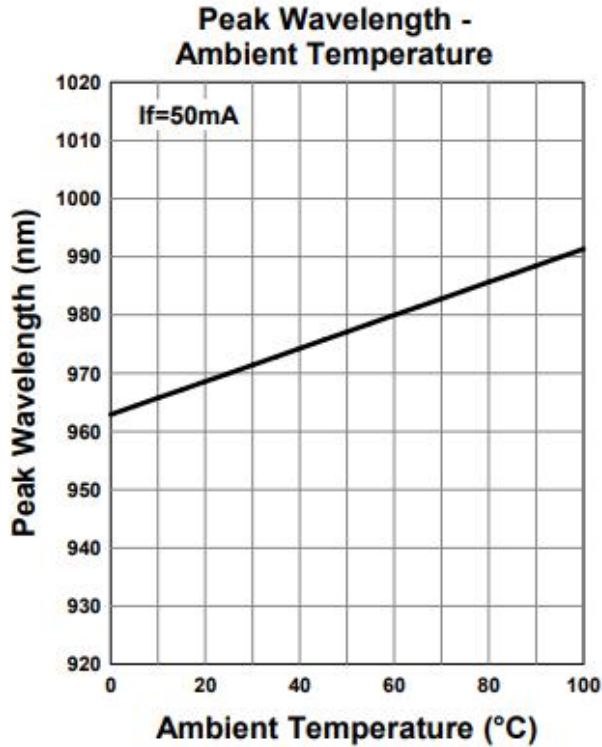
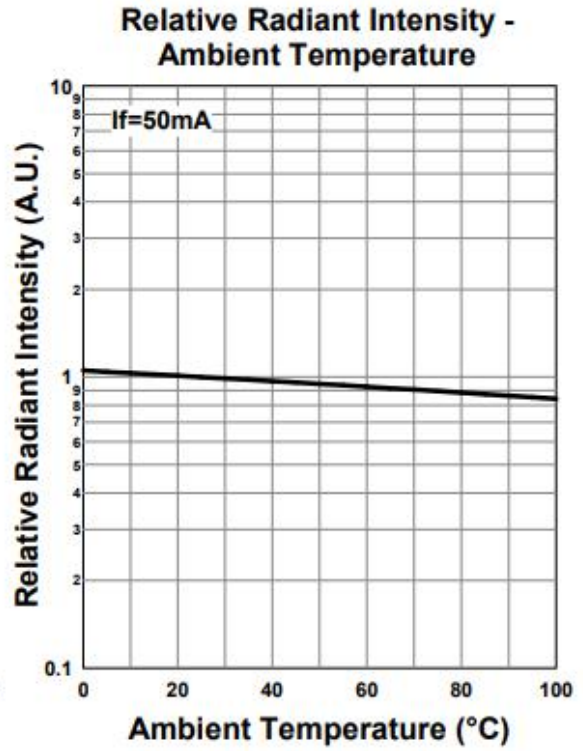
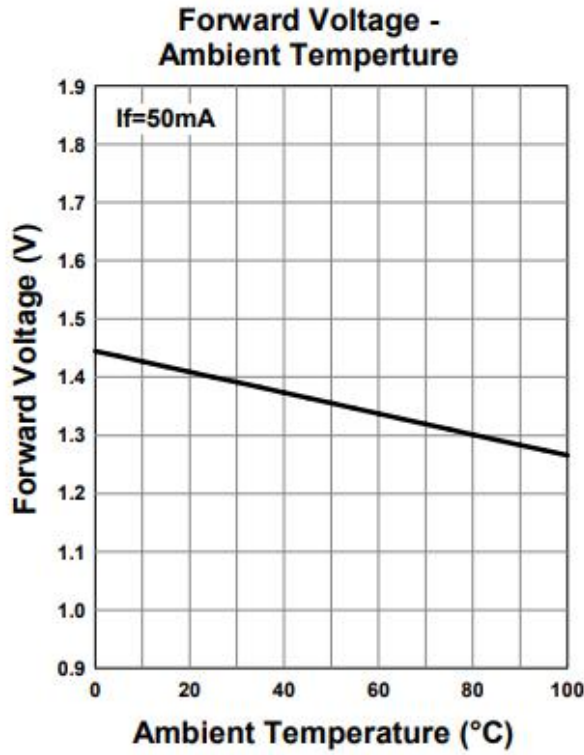

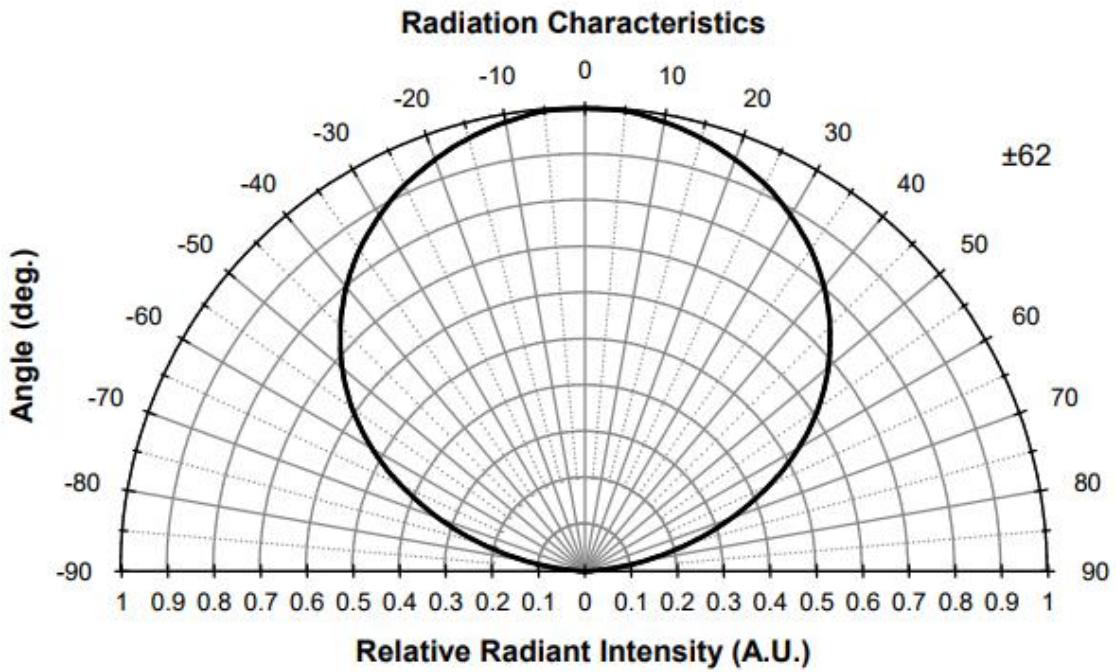
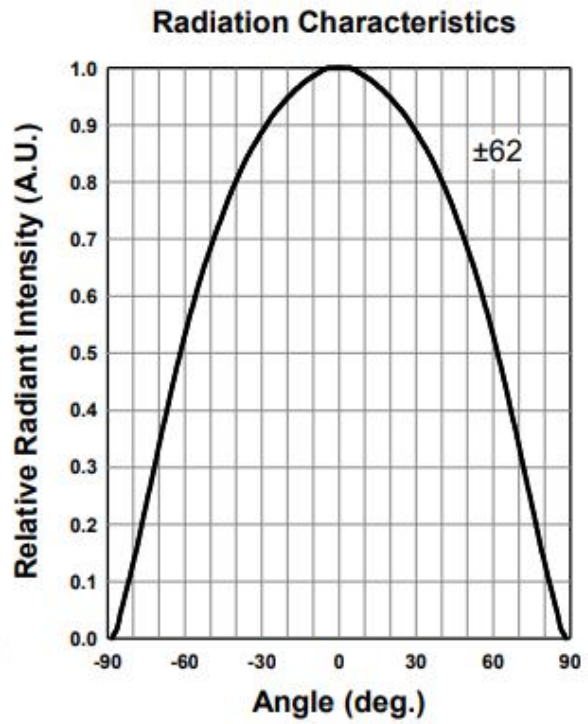
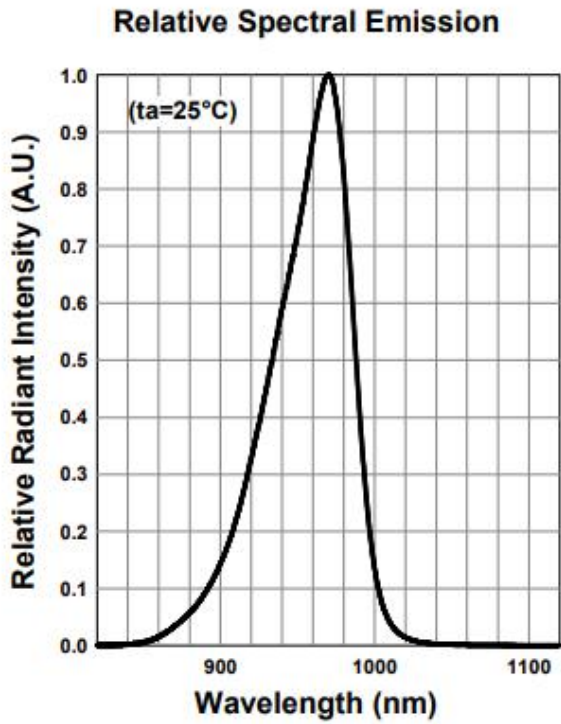

6. Reliability Test

Classification	Test Item	Test Condition	Reference Standard	Reference Standard
Endurance Test	Operation Life	Ta= Under Room Temperature As Per Data Sheet Maximum Rating	1000HRS (-24HRS,+72HRS)*@20mA	MIL-STD-750D:1026 MIL-STD-883D:1005 JIS C 7021:B-1
	High Temperature, High Humidity Storage	IR-Reflow In-Board, 2 Times Ta= 65±5℃,RH= 90~95%	240HRS±2HRS	MIL-STD-202F:103B JIS C 7021:B-11
	High Temperature Storage	Ta= 105±5℃	1000HRS (-24HRS,+72HRS)	MIL-STD-883D:1008 JIS C 7021:B-10
	Low Temperature Storage	Ta= -55±5℃	1000HRS (-24HRS,+72HRS)	JIS C 7021:B-12
Environmental Test	Temperature Cycling	105℃ ~ 25℃ ~ -55℃ ~ 25℃ 30mins 5mins 30mins	10 Cycles	MIL-STD-202F:107D MIL-STD-750D:1051 MIL-STD-883D:1010 JIS C 7021:A-4
	Thermal Shock	IR-Reflow In-Board, 2 Times 85 ± 5℃ ~ -40℃ ± 5℃ 10mins 10mins	10 Cycles	MIL-STD-202F:107D MIL-STD-750D:1051 MIL-STD-883D:1011
	Solder Resistance	T.sol= 260 ± 5℃	10 ± 1secs	MIL-STD-202F:210A MIL-STD-750D:2031 JIS C 7021:A-1
	IR-Reflow Normal Process	Ramp-up rate(183℃ to Peak) +3℃/ second max Temp. maintain at 125(±25)℃ 120 seconds max Temp. maintain above 183℃ 60-150 seconds Peak temperature range 235℃+5/-0℃ Time within 5℃ of actual Peak Temperature (tp) 10-30 seconds Ramp-down rate +6℃/second max	----	MIL-STD-750D:2031.2 J-STD-020C
	IR-Reflow Pb Free Process	Ramp-up rate(217℃ to Peak) +3℃/ second max Temp. maintain at 175(±25)℃ 180 seconds max Temp. maintain above 217℃ 60-150 seconds Peak temperature range 260℃+0/-5℃ Time within 5℃ of actual Peak Temperature (tp) 20-40 seconds Ramp-down rate +6℃/second max	----	MIL-STD-750D:2031.2 J-STD-020C
Solderability	T.sol= 235 ± 5℃ Immersion rate 25±2.5 mm/sec Coverage ≧ 95% of the dipped surface	Immersion time 2±0.5 sec	MIL-STD-202F:208D MIL-STD-750D:2026 MIL-STD-883D:2003 IEC 68 Part 2-20 JIS C 7021:A-2	

7. Cautions

Reflow soldering profile for LEAD-FREE SMD process

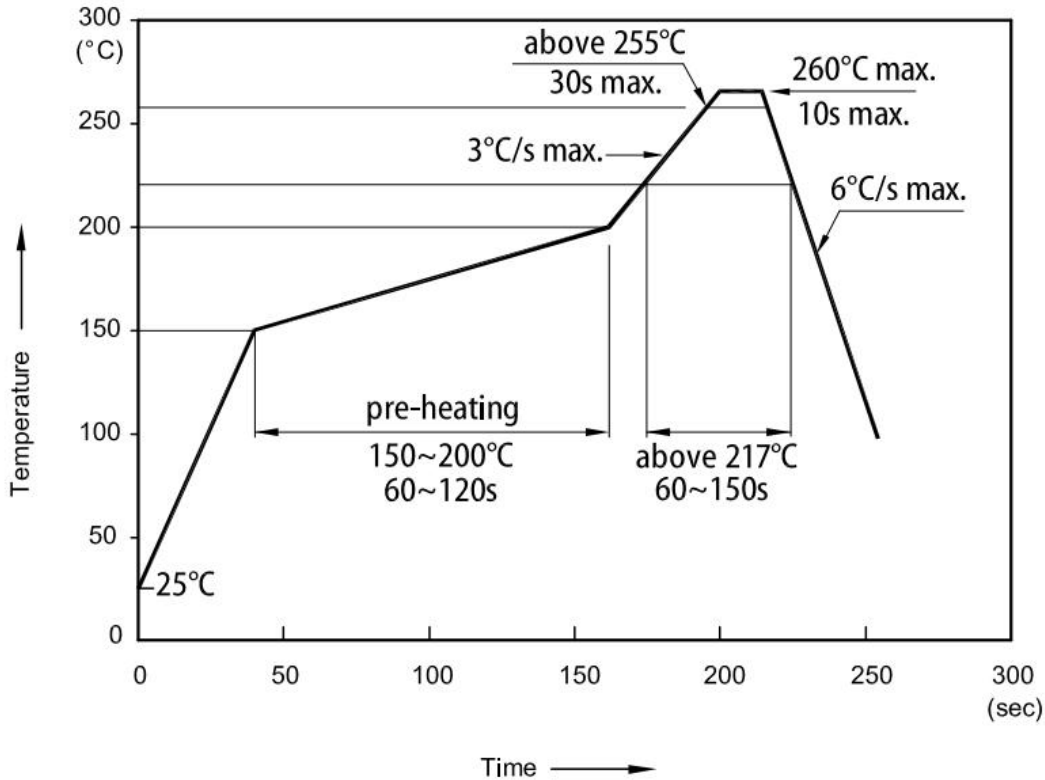

Notes:

1. Don't cause stress to the LEDs while it is exposed to high temperature.
2. The maximum number of reflow soldering passes is 2 times
3. Reflow soldering is recommended. Other soldering methods are not recommended as they might cause damage to the product

HANDLING PRECAUTIONS

Compare to epoxy encapsulant that is hard and brittle, silicone is softer and flexible. Although its characteristic significantly reduces thermal stress, it is more susceptible to damage by external mechanical force. As a result, special handling precautions need to be observed during assembly using silicone encapsulated LED products. Failure to comply might lead to damage and premature failure of the LED.

1. Handle the component along the side surfaces by using forceps or appropriate tools.



2. Do not directly touch or handle the silicone lens surface. It may damage the internal circuitry.

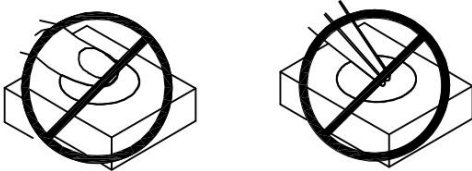

3. Do not stack together assembled PCBs containing exposed LEDs. Impact may scratch the silicone lens or damage the internal circuitry.



4. 4-A The inner diameter of the SMD pickup nozzle should not exceed the size of the LED to prevent air leaks

4-B A pliable material is suggested for the nozzle tip to avoid scratching or damaging the LED surface during pickup

4-C The dimensions of the component must be accurately programmed in the pick-and-place machine to insure precise pickup and avoid damage during production

4-D As silicone encapsulation is permeable to gases, some corrosive substances such as H₂S might corrode silver plating of leadframe. Special care should be taken if an LED with Silicone encapsulation is to be used near such substances.

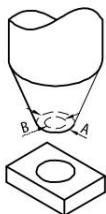

5. Avoid continued exposure to the condensing moisture environment and keep the product away from rapid transitions in ambient temperature.

6. Product in the original sealed package is recommended to be assembled within 24 hours of opening.