

HSF

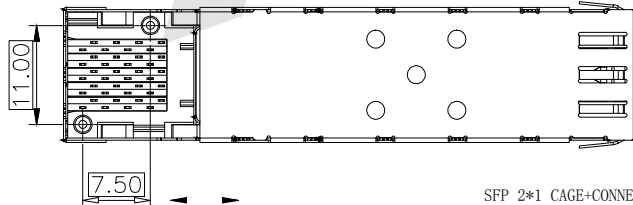

63.25

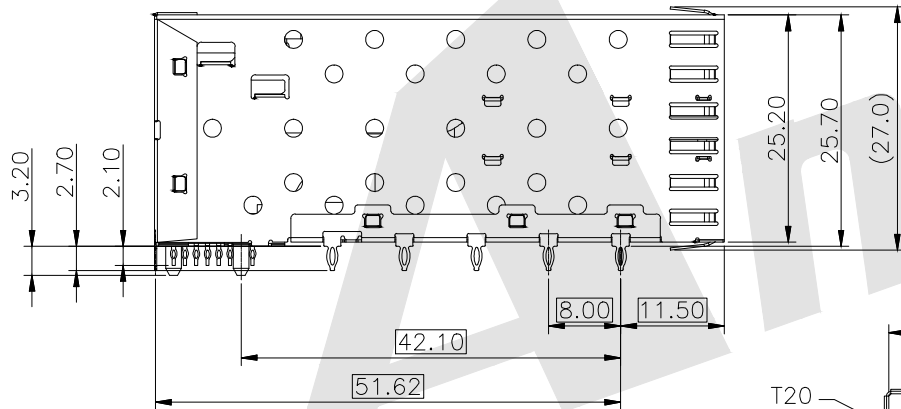
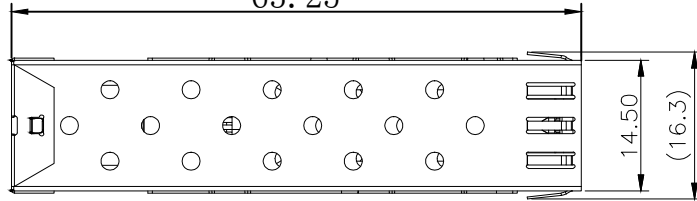

SFP 2*1 CAGE+CONNECTOR

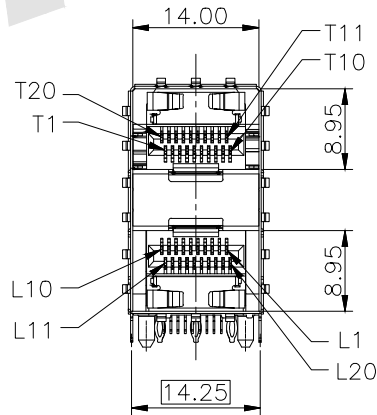

NOTES:

MATERIAL:

CAGE: NICKEL SILVER, THICKNESS 0.25mm

CONNECTOR:

PLASTIC HOUSING: HIGH TEMPERATURE LCP, UL94V-0.

SPRING: STAINLESS STEEL, THICKNESS 0.20MM

PLATING: 15u"MIN. GOLD ON MATING AREA,

150u"MIN. MATE TIN ON SOLDER TAILS.

PACKAGING: TRAY PACKAGING.

TEMPERATURE RANGE: -40°C TO +85°C

ORDER CODE:

ATSFP - IN32002-00B

① ②

① SFP CAGE

② Series number

Unless Otherwise specified tolerance
X. ±0.35 X.XX: ±0.20
X.X: ±0.25 X.XXX: ±0.15

SCALE: As Shown UNIT: mm

DRAW Lv Xun Hua DATE 27/07/2019

CHECK BobYang DATE 27/07/2019

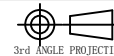

Antenk ANTEK ELECTRONICS CO., LTD
Http://www.antenk.com
E-mail:sales@antenk.com

TITLE:

SFP 2*1 CAGE+CONNECTOR

DRAWING NO: ATSFP - IN3A002-00B

PRODUCT NO: ATSFP - IN3A002-00B

D

D

REV	DESCRIPTION	DATE
1		

HSF

RoHS

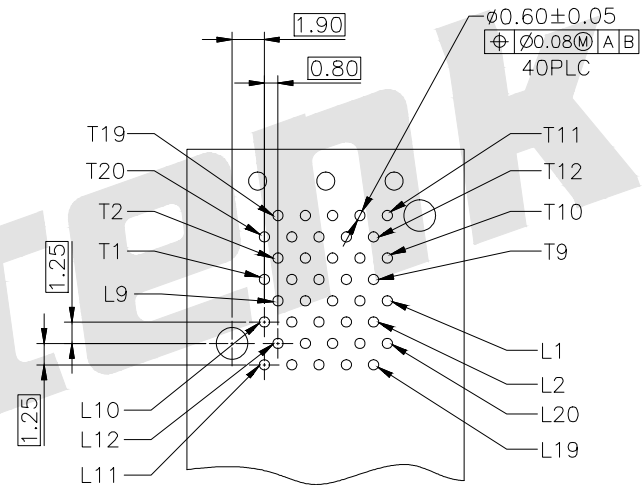
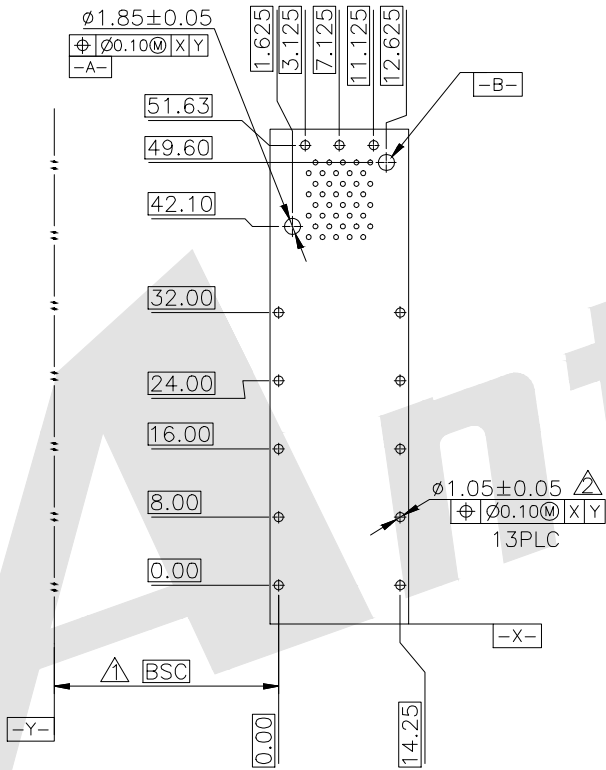

ECOMMENDED PCB CONFIGURATION

NOTES:

1. DATUM AND BASIC DIMENSIONS ESTABLISHED BY CUSTOMER.
2. 1.05 mm DIAMETER HOLES ARE CHASSIS GROUND .

Unless Otherwise specified tolerance
 X. ± 0.35 X.XX: ± 0.20
 X.X: ± 0.25 X.XXX: ± 0.15



ANTENK ELECTRONICS CO., LTD
 Http://www.antenk.com
 E-mail:sales@antenk.com

SCALE: As Shown UNIT: mm
 DRAW Lv Xun Hua DATE 27/07/2019
 CHECK BobYang DATE 27/07/2019

TITLE:
 SFP 2*1 CAGE+CONNECTOR



DRAWING NO: ATSFP - 1N3A002-00B
 PRODUCT NO: ATSFP - 1N3A002-00B

REV	DESCRIPTION	DATE
1		
2		
3		
4		
5		

HSF



ROHS

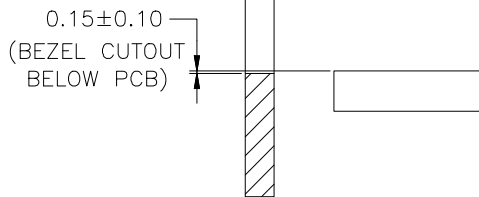
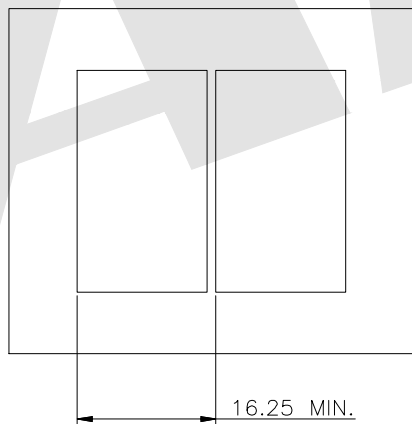
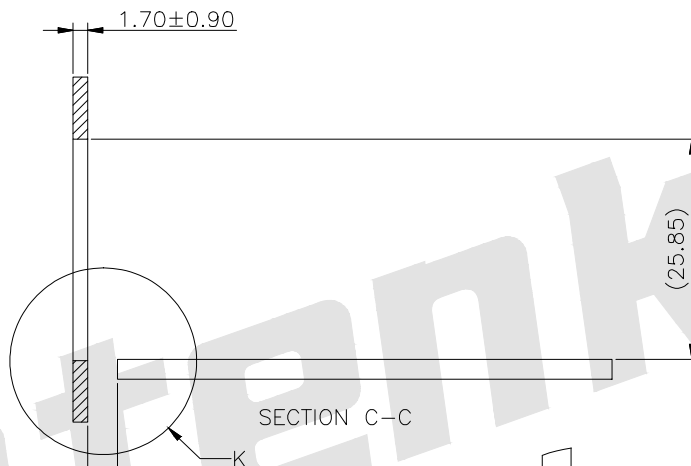
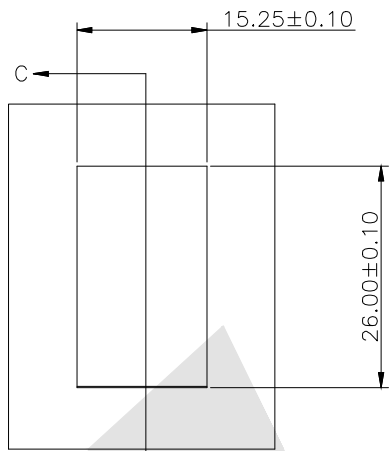

RECOMMENDED BEZEL DESIGN

Unless Otherwise specified tolerance
 X. ±0.35 X.XX: ±0.20
 X.X: ±0.25 X.XXX: ±0.15



ANTENK ELECTRONICS CO., LTD
[Http://www.antenk.com](http://www.antenk.com)
 E-mail:sales@antenk.com

SCALE: As Shown	UNIT: mm
DRAW Lv Xun Hua	DATE 27/07/2019
CHECK BobYang	DATE 27/07/2019

TITLE:
SFP 2*1 CAGE+CONNECTOR



DRAWING NO: ATSP - 1N3A002-00B
 PRODUCT NO: ATSP - 1N3A002-00B

REV	DESCRIPTION	DATE

