

SE50-9

Small size, big efficiency

- ▶ Engine model: Kubota V2607 (Tier 3)
- ▶ Rated power: 35 kW/2200 rpm
- ▶ Operating weight: 5.28 t

Product features

*Originally imported Kubota engine. The engine conforms to China-III emission regulation and features strong power, low fuel consumption, and prominent performance and the aluminum paralleling radiator features good heat dissipation performance.

*Originally imported hydraulic system. The four-pump constant power control mode is adopted to realize the perfect matching between hydraulic system and engine, reduce the fuel consumption, and improve the efficiency and the double-pump confluence technology is applied for the boom and arm to realize high motion speeds and stable and efficient operations.

*Electro-mechanically integrated intelligent electronic control system with proprietary intellectual property rights. The multi-functional LCD display can realize the data acquisition and transmission, orientation, control, protection, and remote firmware upgrade and achieve high intelligent control.

*All-new cab with broader vision field and more reasonable space layout. The air-cushioned seats and the ergonomic control system realize simpler and more comfortable operations and minimize the driver's fatigue.

*High reliability traveling mechanism and working device. The application of strength calculation, finite element analysis, and new structures and new materials for the structural parts improves the reliability of the structural parts.

*Convenient repairs and maintenances. The application of full-opening front and rear hoods and side gates and the central lubrication system for slewing system realizes convenient and efficient maintenances and reduces the maintenance costs.



shantui e-shop

SHANTUI

VALUE THAT WORKS

Shantui Construction Machinery Co., Ltd.

ADDRESS:
No. 58, G327 Highway
Jining City, Shandong, CHINA

TEL: +86-537-2909369
FAX: +86-537-2311219
EMAIL: trade@shantui.com

SE50-9

Technical specifications:

Minimum ground clearance: 330 mm

Overall length: 5710 mm







Operating weight: 5.28 t

Overall height: 2545 mm

Ground pressure: 30.5 kPa

Overall width: 1865 mm

SE50-9

	ENGINE	Model	Kubota V2607
		Type	4-cylinder in line, natural intake, water-cooled
		Quantity of cylinders	4
		Bore x stroke	87 x 110 mm
		Displacement	2.615 L
		Power output	35 kW/2200 rpm
		Maximum torque	171.5NM/1100-1500rpm
	HYDRAULIC SYSTEM	Pump	Imported
		Type	Variable piston pump
		Maximum discharge flow	139 L/min
		Control circuit	3.9 MPa
		Travel circuit	24.5 MPa
		Swing circuit	18.6 MPa
	TRAVEL SYSTEM	Travel motor	Variable axial piston
		Travel brakes	Lubricated double-disc
		Parking brake	Pressure release
		Travel shoes	2 x 39
		Travel speed	4.26 km/h
		Drawbar pulling force	40 kN
		Gradeability	58%
		Minimum ground clearance	330 mm
	OIL CAPACITY	Fuel tank	110 L
		Cooling system	8.5 L
		Engine oil	9 L
		Hydraulic oil tank	101 L
		System capacity	120 L
	SWING SYSTEM	Brake	Pressure Release Mechanical Braking
		Swing speed	9.7 rpm
		Tail swing radius	1575 mm
		Arm digging force	23.7 KN
		Bucket digging force	33.6 KN
	BUCKET	Bucket capacity	Backhoe bucket 0.2 m ³ (SAE)
		Number of bucket teeth	4
		Bucket width	750 mm
		Arm length	1.70 m
		Maximum digging reach/Maximum digging reach at ground level	6 m/5.88 m
		Maximum digging depth/height	3.72 m/5.665 m
		Maximum dumping height	4.03 m
		Minimum swing radius	2.09 m

OVERALL DIMENSIONS

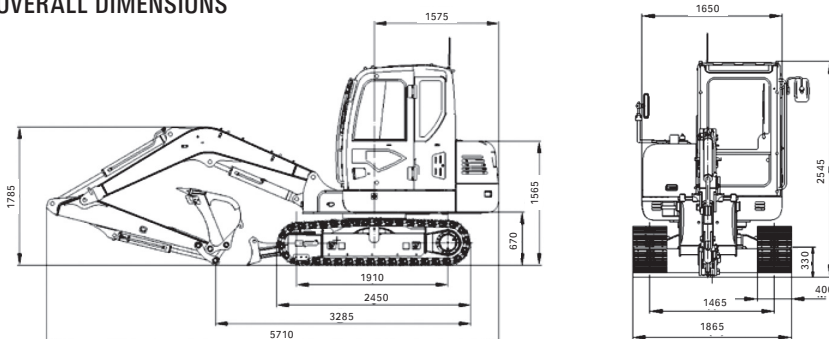

▶ THE SPECIFICATIONS ARE SUBJECT TO CHANGE WITHOUT NOTICE. THE PICTURES MAY INCLUDE OPTIONS. THE ACTUAL COLOR & APPEARANCE OF THE PRODUCT MAY DIFFER FROM WHAT IS SHOWN.

WWW.SHANTUI.COM