

1.1W

106LM

160°

IP65

LifeSpan  
50,000h



## Features >

- Sourced by high output SMD2835, good color conformity and no spot.
- 99.99% gold thread, pure copper bracket coated with silver.
- Constant current driving technology guarantees stable performance of product.
- SDCM≤5 each BIN.
- Special lens design, 160°beaming angle with even light.
- Overmoulded: anti-dusting, anti-moisture, waterproof, anti-shock.
- 50 pcs Max. in a series connection.
- CE, ROHS and UL certified.

## Application >

- Best for 8-12 cm depth signs at airports, metros, banks, buildings and shopping malls, etc.

Parameters >

Items	Parameters
Part Number	ZE03QB7
CCT ( K )	7000K
Beaming Angle ( ° )	160
CRI ( Ra )	≥75
Luminous Flux ( lm )	106
Voltage ( V )	DC12
Power ( W )	1.1
Driving Method	Inner Constant Current
Dimension ( mm )	74.4*15*9.2
Weight ( g )	9.57
Working Tem. ( °C )	-25 ~ +60
Storage Tem. ( °C )	-25 ~ +70
Protection Grade	IP65

Dimension >

Unit:mm

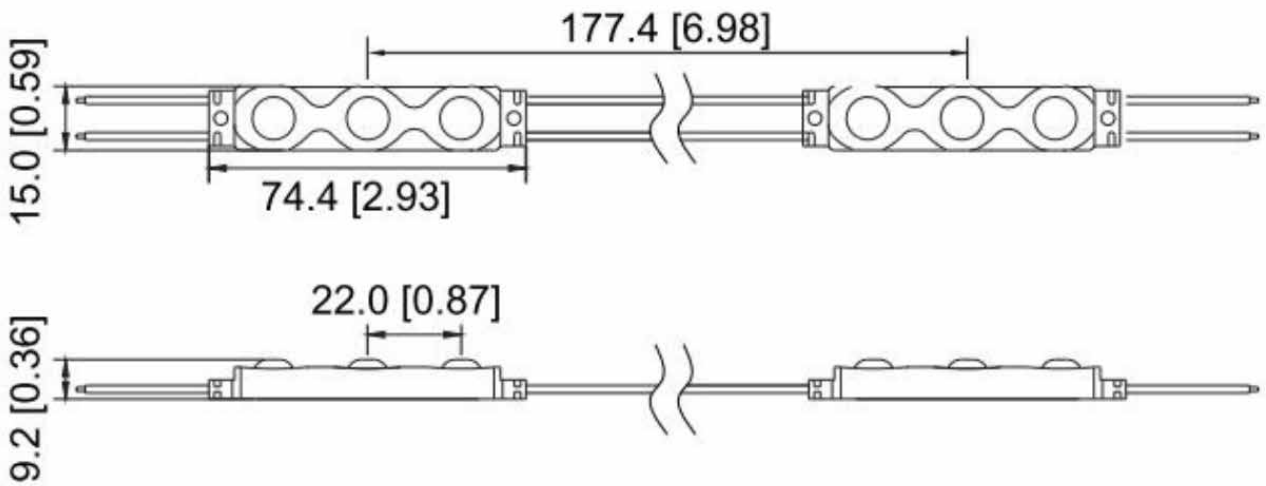

Beaming Angle >

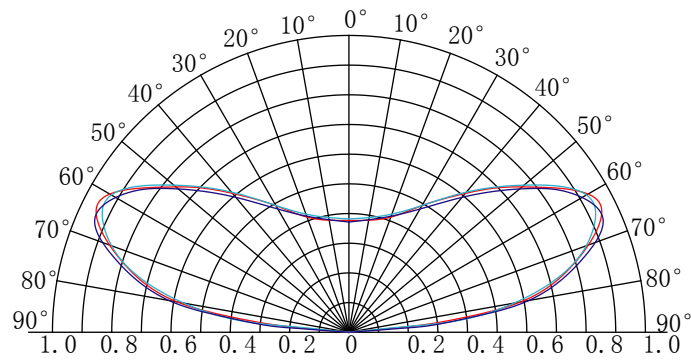

Reference Scheme >

Depth(mm)	Distance(mm)	Density(pcs/m <sup>2</sup> )	Illumination(lux)
Dz=60	Dx=100 Dy=50	200	8800-9500
Dz=80	Dx=120 Dy=70	119	5000-5500
Dz=100	Dx=140 Dy=90	79	2500-2800
Dz=120	Dx=160 Dy=110	57	1600-2000
Dz=150	Dx=190 Dy=130	40	1200-1500

Remark:

- The transmittance of the Acrylic was 56%.
- The above data is for reference only.

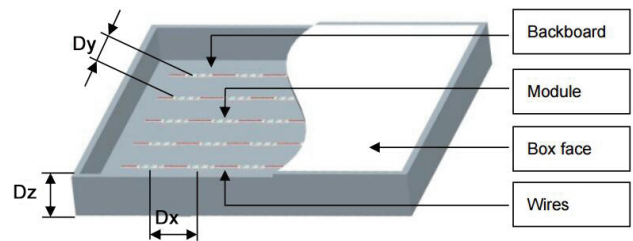

Wire Connection >

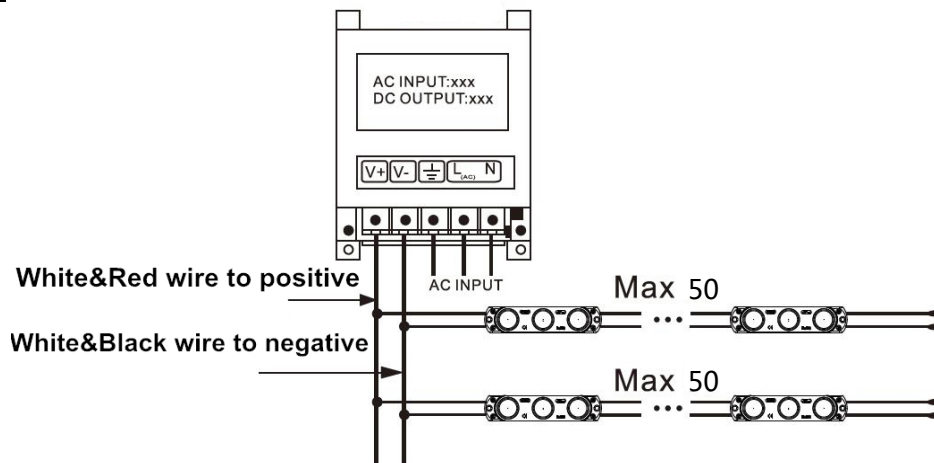

## Packing

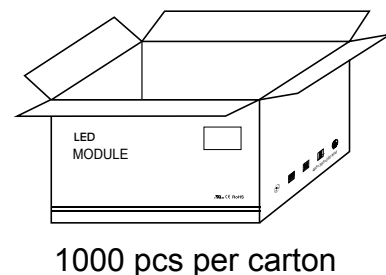
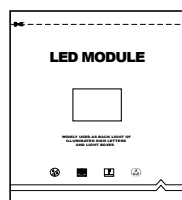
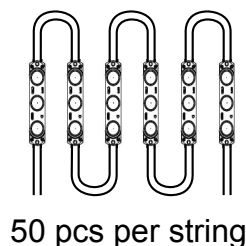

## Packing Specification

- Antistatic bag adopted
- Packing information

Part Number	ZE03QB7
Carton dimension(mm)	490*450*220
Bags per carton	10
Quantity per carton(pcs)	1000
Net Weight(kg)	12.8 (1±10%)
Gross Weight(kg)	13.8 (1±10%)

- Due to the packing manner difference, please subject to the original products in case of discrepancy found between the picture and actual product.

## Warning

- Disassembling or modifying the product is forbidden.
- Installation with power on is forbidden.
- Any organic solvent chemical is forbidden.
- Acidic or alkaline adhesive is forbidden when install, neutral glass cement could be used for installation purpose, make it drying in open environment for four hours.
- Isolation and corrosion prevention on all wiring points and wire ends.
- Make sure the power wire is thick enough and ensure the voltage and connections are connected correctly before power on.
- This product should be used in a sign, do not expose it in opening site.
- Installation, maintaining should be done by professional staff.
- 50 pcs in a serial connection maximum.
- The power wire between power supply and module should be less than two meters to keep the same brightness on all parts.

## Declaration



- Warranty: 5 years.
- In order to ensure the safety, the broken wires need to be replaced by the manufacturer or the service agent, or by the staff with the similar qualification.
- The given data in the specification was based on the laboratory testing, there may be discrepancy found in the actual products.
- The given drawings in the specification are only for reference, there may be discrepancy found in the actual products.
- The products are subject to change without prior notification.



**Company Address:**

Rm. WS, 9F, LuBan Building, Hongli West Road, Futian District, Shenzhen, China 518034

**Factory Address:**

No. B, Xinyongfeng Industrial Area, Yingrenshi Village, Shiyuan Town, Bao'an District, Shenzhen, China 518000

**TEL:** +86-755-83544570

**FAX:** +86-755-83056229

**Website:** [www.lbyled.com](http://www.lbyled.com)

**E-mail:** [info@szlby.cn](mailto:info@szlby.cn)



**LBY LED**  
signs never been so easy