

1.1W

106LM

160°

IP65

LifeSpan
50,000h



Features



- Sourced by high output SMD2835, good color conformity and no spot.
- 99.99% gold thread, pure copper bracket coated with silver.
- Constant current driving technology guarantees stable performance of product.
- SDCM≤5 each BIN.
- Special lens design, 160°beaming angle with even light.
- Overmoulded: anti-dusting, anti-moisture, waterproof, anti-shock.
- 50 pcs Max. in a series connection.
- CE, ROHS and UL certified.

Application



- Best for 8-15 cm depth signs at airports, metros, banks, buildings and shopping malls, etc.

Parameters >

Items	Parameters
Part Number	ZE03QB7
CCT (K)	7000K
Beaming Angle (°)	160
CRI (Ra)	≥75
Luminous Flux (lm)	106
Voltage (V)	DC12
Power (W)	1.1
Driving Method	Inner Constant Current
Dimension (mm)	74.4*15*9.2
Weight (g)	9.57
Working Tem. (°C)	-25 ~ +60
Storage Tem. (°C)	-25 ~ +70
Protection Grade	IP65

Dimension >

Unit:mm

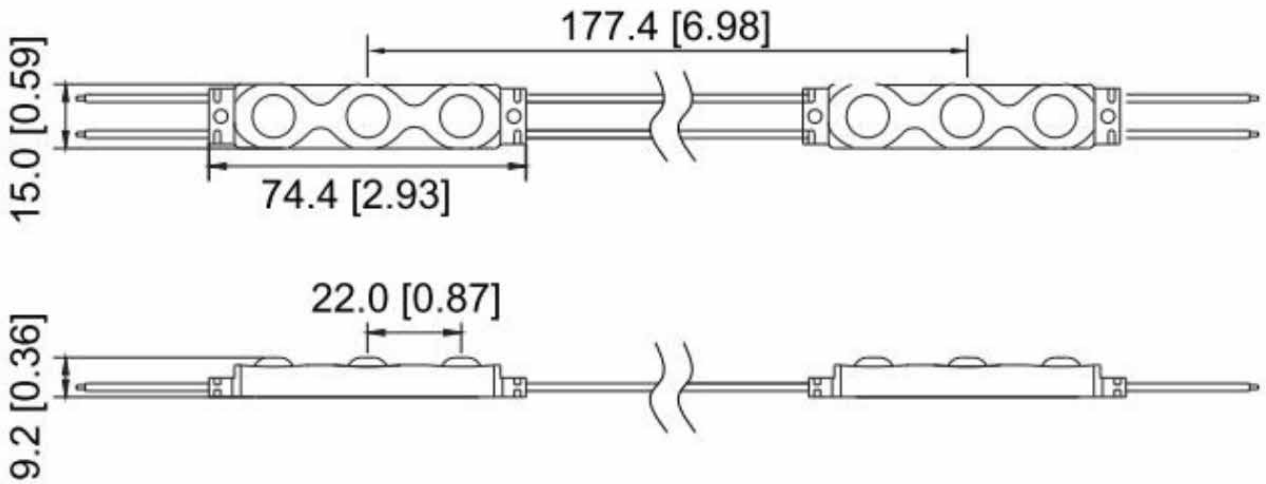

Beaming Angle >

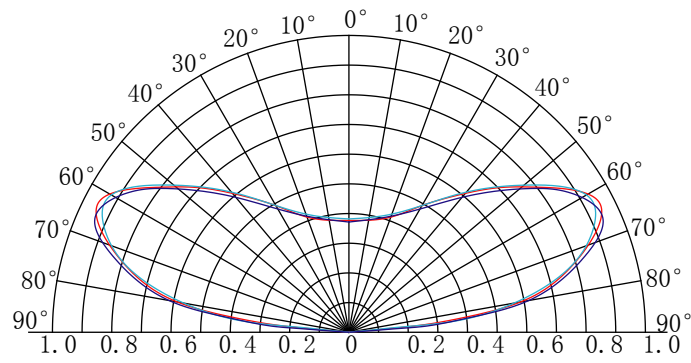

Reference Scheme >

Depth(mm)	Distance(mm)	Density(pcs/m ²)	Illumination(lux)
Dz=60	Dx=100 Dy=50	200	8800-9500
Dz=80	Dx=120 Dy=70	119	5000-5500
Dz=100	Dx=140 Dy=90	79	2500-2800
Dz=120	Dx=160 Dy=110	57	1600-2000
Dz=150	Dx=190 Dy=130	40	1200-1500

Remark:

- The transmittance of the Acrylic was 56%.
- The above data is for reference only.

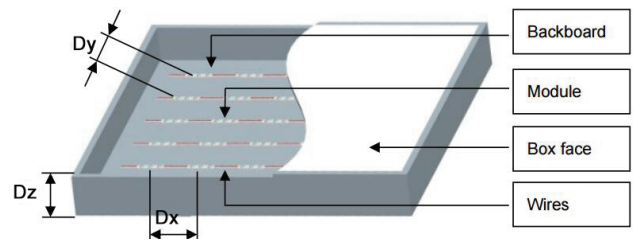

Wire Connection >

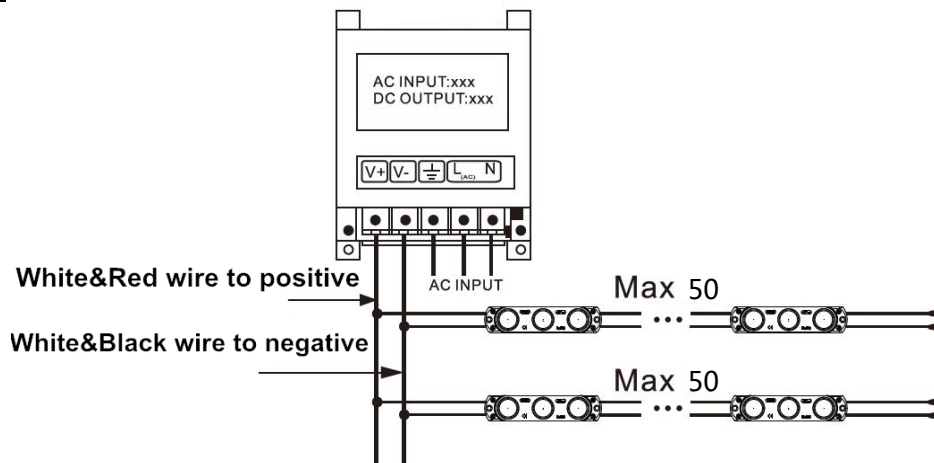

Packing

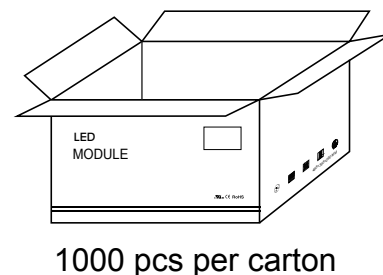
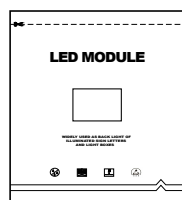
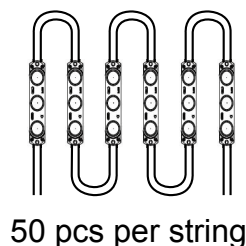

Packing Specification

- Antistatic bag adopted
- Packing information

Part Number	ZE03QB7
Carton dimension(mm)	490*450*220
Bags per carton	10
Quantity per carton(pcs)	1000
Net Weight(kg)	12.8 (1±10%)
Gross Weight(kg)	13.8 (1±10%)

- Due to the packing manner difference, please subject to the original products in case of discrepancy found between the picture and actual product.

Warning

- Disassembling or modifying the product is forbidden.
- Installation with power on is forbidden.
- Any organic solvent chemical is forbidden.
- Acidic or alkaline adhesive is forbidden when install, neutral glass cement could be used for installation purpose, make it drying in open environment for four hours.
- Isolation and corrosion prevention on all wiring points and wire ends.
- Make sure the power wire is thick enough and ensure the voltage and connections are connected correctly before power on.
- This product should be used in a sign, do not expose it in opening site.
- Installation, maintaining should be done by professional staff.
- 50 pcs in a serial connection maximum.
- The power wire between power supply and module should be less than two meters to keep the same brightness on all parts.

Declaration



- Warranty: 5 years.
- In order to ensure the safety, the broken wires need to be replaced by the manufacturer or the service agent, or by the staff with the similar qualification.
- The given data in the specification was based on the laboratory testing, there may be discrepancy found in the actual products.
- The given drawings in the specification are only for reference, there may be discrepancy found in the actual products.
- The products are subject to change without prior notification.



Company Address:

Rm. WS, 9F, LuBan Building, Hongli West Road, Futian District, Shenzhen, China 518034

Factory Address:

No. B, Xinyongfeng Industrial Area, Yingrenshi Village, Shiyuan Town, Bao'an District, Shenzhen, China 518000

TEL: +86-755-83544570

FAX: +86-755-83056229

Website: www.lbyled.com

E-mail: info@szlby.cn



LBY LED
signs never been so easy