

2700k 3000k 4000k 6500k

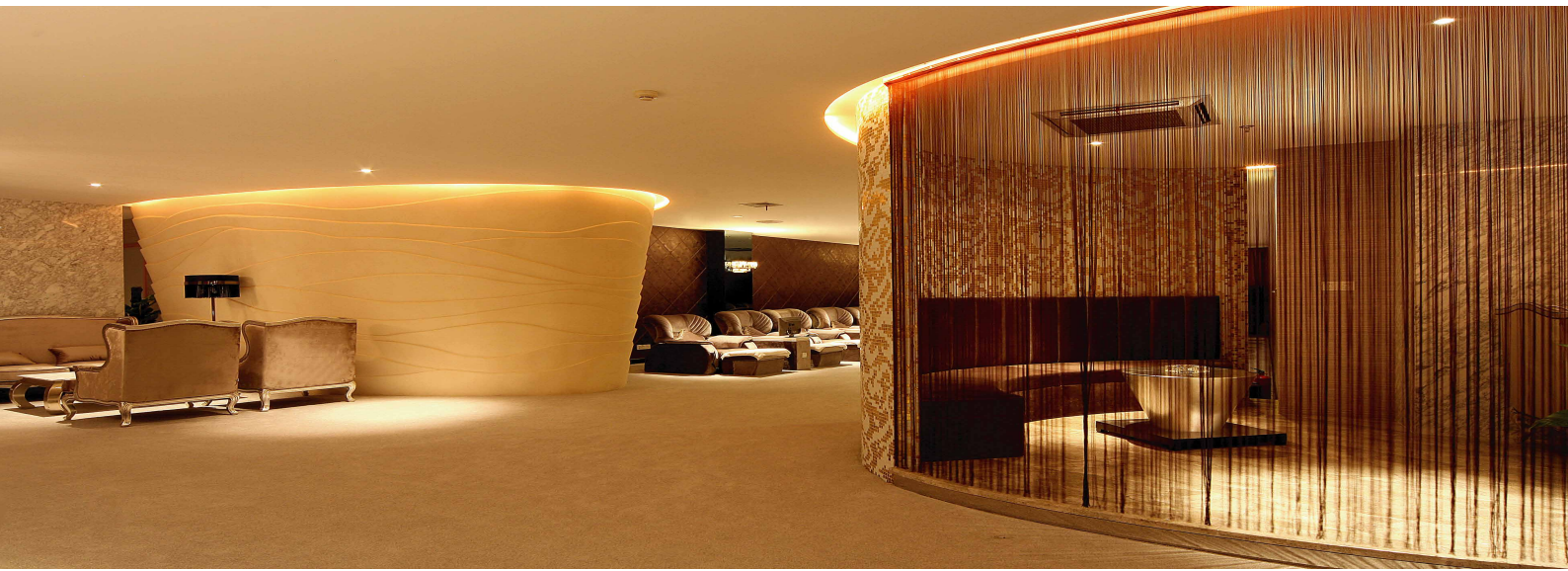

## Features >

- Sourced by high output 2835 LED with good color conformity.
- 99.99% gold thread, pure copper bracket coated with silver.
- USA Intematix phosphor with CRI > 80.
- SDCM ≤ 5 each BIN.
- Double layer rolled copper FPC.
- 3M 300LSE tape attached.
- CE, RoHS and UL certified.

## Application >

- City lighting, landscape lighting, commercial lighting and house contour lighting, etc.

# Advantages >

## Different IP options

**IP33**

Non-proof



Indoor

**IP55**

Glue coating



In humid air

## Full CCT ranges from 2700K to 6500K

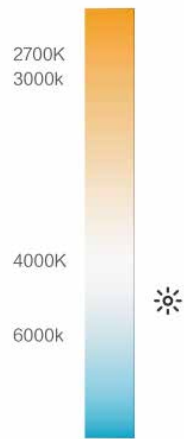
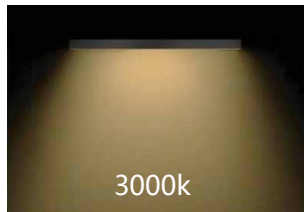
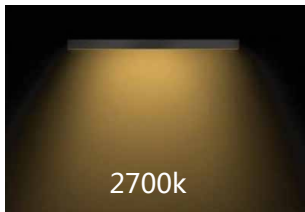

## Various CRI option from 75 to 95

CRI 95

CRI 75



Parameters >

Part Number	Dimensions(mm)	LED Type	LEDs/m	Voltage(V)	Power(W/m)	LM/M	CCT/K	IP Grade
SEO0LC1	5000*12	SMD 2835	240	DC24	24	2200	6500	IP33

Dimension >

Unit:mm

IP33

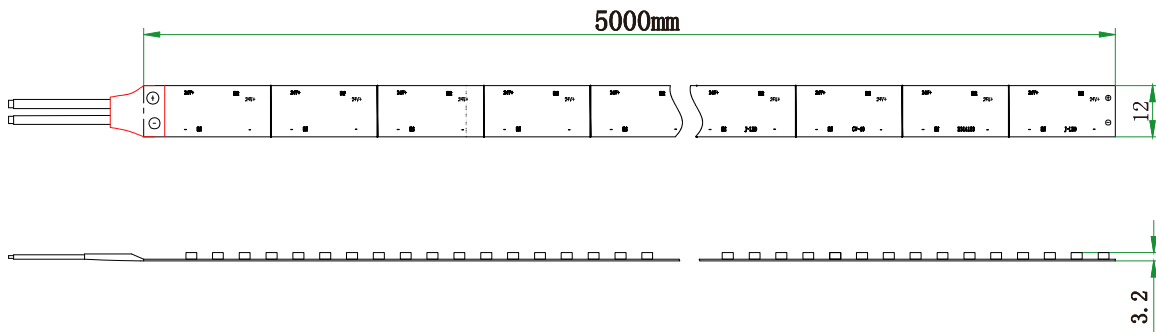

Beaming Angle >

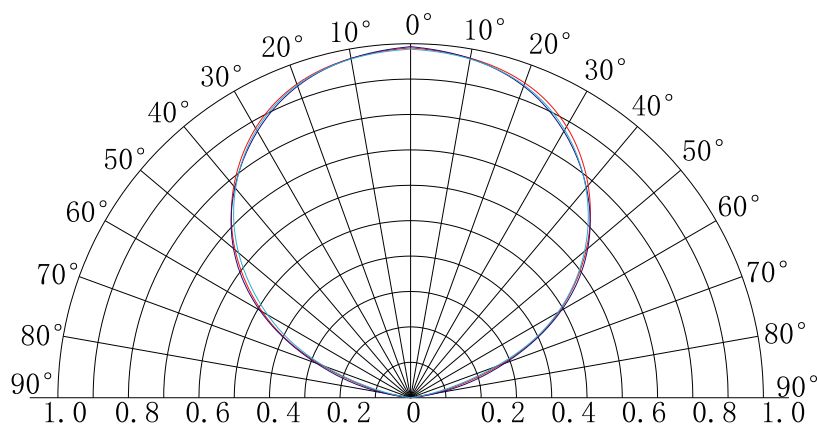

## Wire Connection >

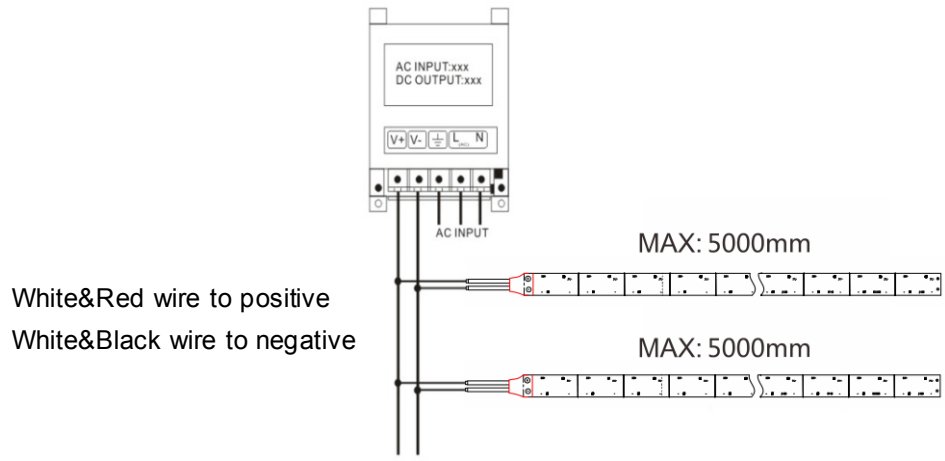

## Packing >

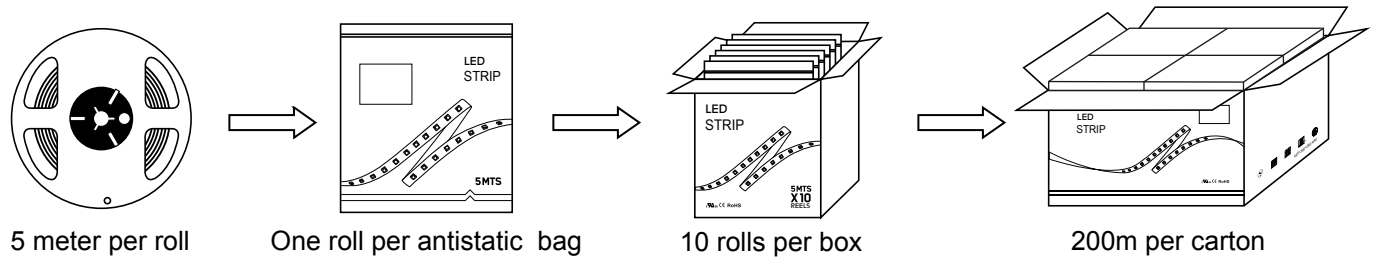

## Packing Specification >

- Antistatic bag adopted
- Packing information

Part Number	Carton dimension(mm)	Bags per carton(pcs)	Quantity per carton(m)	Net Weight(kg)	Gross Weight(kg)
SEO0LC1	495*395*290	40	200	7.0	10.5

- Due to the packing manner difference, please subject to the actual package in case of discrepancy found between the datasheet and actual package.

## Warning



- Disassembling or modifying the product is forbidden.
- Installation with power on is forbidden.
- Any organic solvent chemical is forbidden.
- Isolation and corrosion prevention on all wiring points and wire ends.
- Make sure the power wire is big enough and ensure the voltage and connection are all correct before power on.
- Installation, maintenance should be done by professional staff.
- 5M in a serial connection maximum for DC24V strips.
- The power wire between power supply and LED strips should be less than two meters to keep the same brightness on all parts.

## Declaration



- Warranty: 3 years.
- To ensure the safety, the broken wires need to be replaced by the manufacturer or the service agent, or by the qualified staff.
- The given data in the specification is the laboratory data, there may be discrepancy found in the actual products.
- The given drawings in the specification are only for reference, there may be discrepancy found in the actual products.
- The products are subject to change without prior notification.



**RoHS**

### Company Address:

Rm. WS, 9F, LuBan Building, Hongli West Road, Futian District, Shenzhen, China 518034

### Factory Address:

No. B, Xinyongfeng Industrial Area, Yingrenshi Village, Shiyuan Town, Bao'an District, Shenzhen, China 518000

**TEL:** +86-755-83544570

**FAX:** +86-755-83056229

**Website:** www.lbyled.com

**E-mail:** info@lbyled.com



**LBY LED®**  
signs never been so easy