

MPB22 Series

22mm Metal Pushbutton Switches



SPECIFICATIONS

- RATING** : 1th 5A/250VAC resistive load 3A/250VAC
- CONTACT RESISTANCE** : 50 mΩ max. @ 1A 12VDC (initial value)
- INSULATION RESISTANCE** : 1,000 MΩ min. at 500VDC
- DIELECTRIC STRENGTH** : 2,000V RMS @ sea level
- OPERATION TEMPERATURE** : -20°C to 55°C
- MECHANICAL LIFE** : Momentary 1,000,000 cycles
Self-lock 500,000 cycles
- ELECTRICAL LIFE** : 50,000 make-and-break cycles at full load
- TORQUE** : 5~14Nm
- PANEL THICKNESS** : 10mm (Ø22.20mm)
- OPERATION PRESSURE** : 1Pole 2.5±1N / 2Poles 3.5±1N
- TRAVEL** : About 3.2mm
- INGRESS PROTECTION** : IP67, IK10(Stainless)

MATERIALS

- BUSHING** : Stainless Steel / Aluminum alloy
- BASE** : PBT(UL 94-V0) , PC(UL 94-V2)
- ACTUATOR** : PC; Stainless Steel / Aluminum alloy
- INNER ASSEMBLY** : POM / PA66.
- SPRING** : Spring steel.
- SEALING** : Silicone.
- O-Ring** : Silicone.
- TERMINAL / CONTACT** : Copper ,Silver plated.
- HEX NUT** : Nickel plated brass

HOW TO ORDER



MODEL NO.	BODY TYPE	BUTTON TYPE	CONTACT CONFIGURATION	OPERATING TYPE	LIGHT TYPE	LED COLOR	LED VOLTAGE	TERMINAL SHAPE	TERMINAL PLATING
MPB22	Body type A0 Stainless (Natural) C3 Al alloy (Black Anodized)	Button type F Flat	Contact Configuration 1 1NO 1NC 2 2NO 2NC	Operating type 0 Momentary 1 Lock	Light type 0 Without LED E Ring (Moveable) E2 Illuminated Ring with led color ,red/green/blue availavle only			Terminal shape J Solder terminal T1 Flying lead terminals L=500mm T2 Flying lead terminals L=1000mm T3 Flying lead terminals L=1500mm T4 Flying lead terminals L=2000mm	Terminal plating Q Silver R Gold
MPB22	Body type D0 Stainless (Natural),Flat F3 Al alloy (Black Anodized),flat	Button type F Flat	Contact Configuration 1 1NO 1NC 2 2NO 2NC	Operating type 0 Momentary 1 Lock	Light type E1 Illuminated ring with power logo only availavle in white cap E3 Illuminated ring with power logo with led color,red/green/blue availavle only				

ITEM NO	COLOR
0	Without LED
1	White
3	Red
5	Yellow
6	Green
7	Blue
DUAL COLOR LED	
A	Red&Green
B	Red&Blue
D	Blue&Yellow
G	Red&Yellow
H	Green&Yellow
J	Orange&Green

ITEM NO	VOLTAGE
0	Without LED
3	3V
6	6V
12	12V
24	24V
36	36V
110	110V
220	220V

EXAMPLE:
 MPB22-A0F100-JQ (Without LED)
 MPB22-A0F10E-□-□-JQ
 LED color LED voltage

MPB22 Pushbutton Switches

CIRCUIT

POSITION 1



Without LED (1 Pole)

POSITION 2



POSITION 1

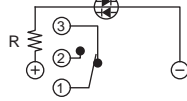

Single Color Led (1 Pole)

POSITION 2

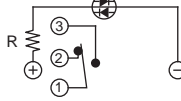

POSITION 1

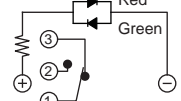

Dua Color Led (1 Pole)

POSITION 2

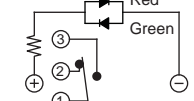

POSITION 1

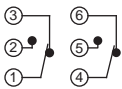

Without LED (2 Poles)

POSITION 2

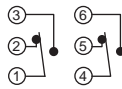

POSITION 1

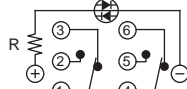

Single Color Led (2 Poles)

POSITION 2



POSITION 1

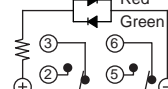

Dua Color Led (2 Poles)

POSITION 2



BODY TYPE

A0/C3 Body

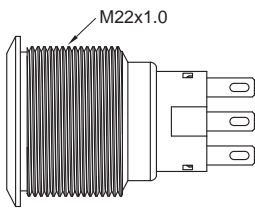

D0/F3 Body (Flat)

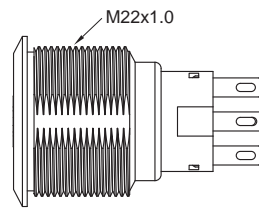

LIGHT TYPE

0 Without LED

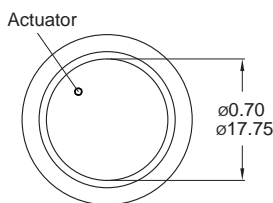

E Ring (Moveable)

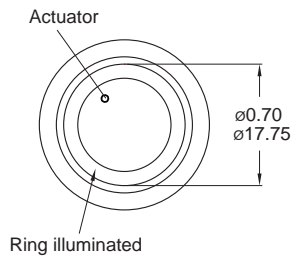

E3 Ring+Power logo

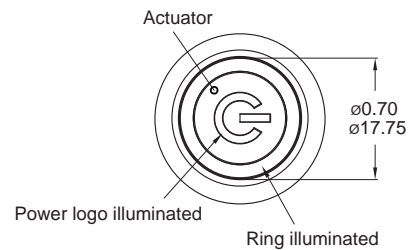

* Only for D0, F3 body.

Wire (Flying lead Terminals)

※ Wire=UL 3385, 18AWG, 300V (Black/Yellow/Green/Red/Purple)

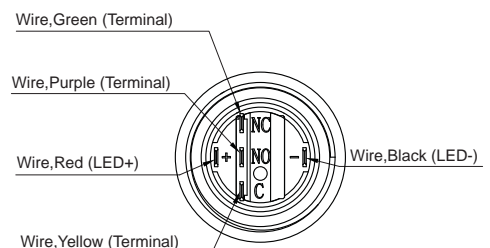
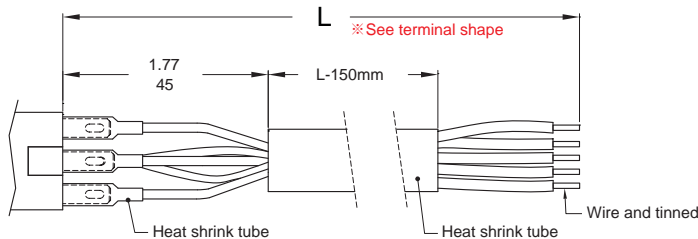

MPB22 Series

22mm Metal Pushbutton Switches

LIGHT TYPE

0 Without LED

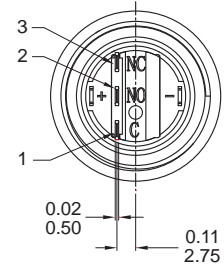
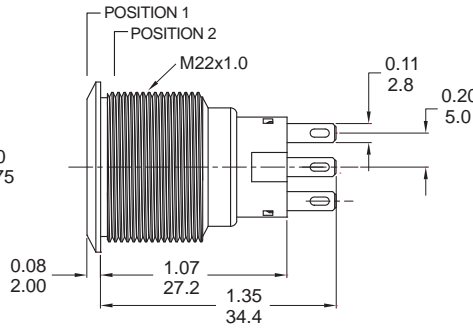
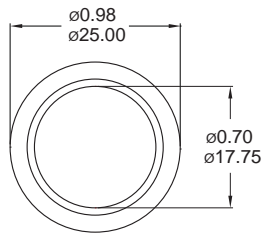

Part No. Shown : MPB22-A0F1□0-JQ

E Ring (Moveable)

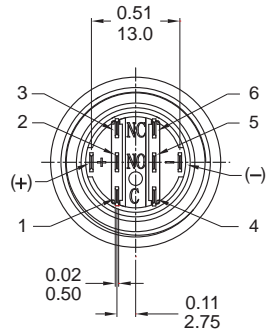
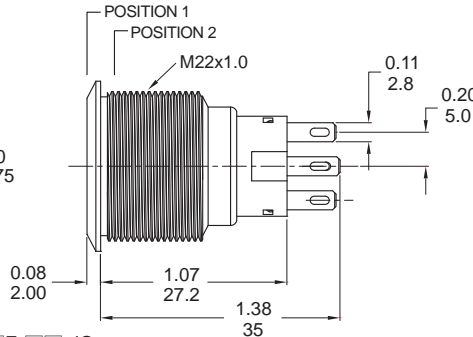
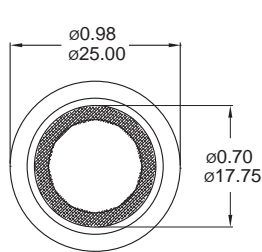

Part No. Shown : MPB22-A0F2□E-□□-JQ

E3 Ring+Power logo

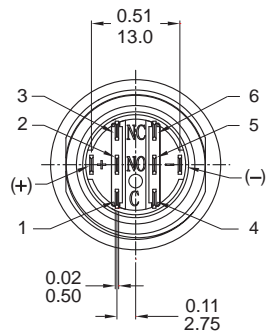
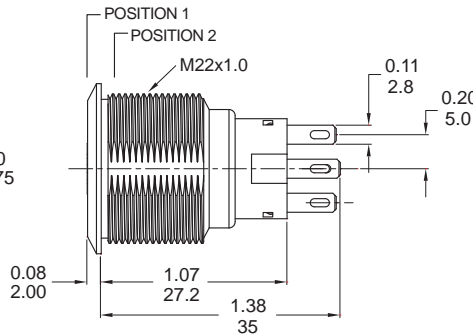
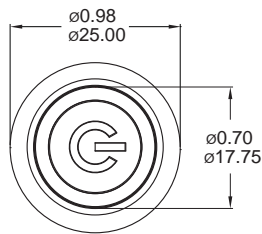

Part No. Shown : MPB22-D0F2□E3-□□-JQ

ASSEMBLED VIEW

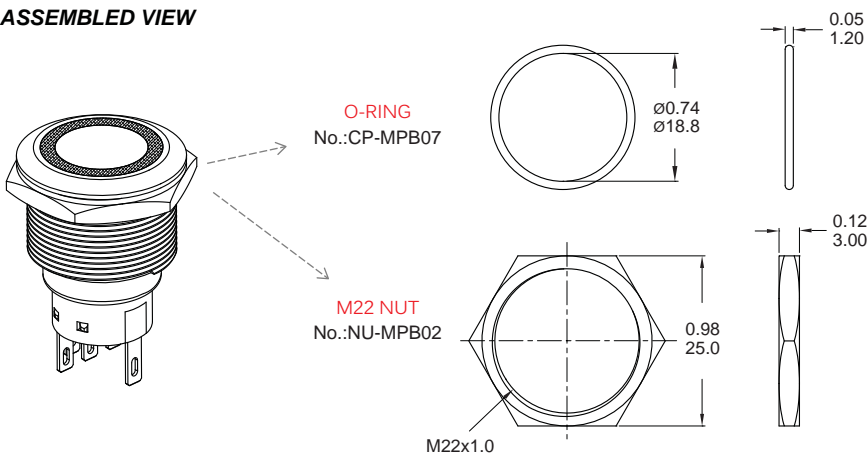

PANEL MOUNTING

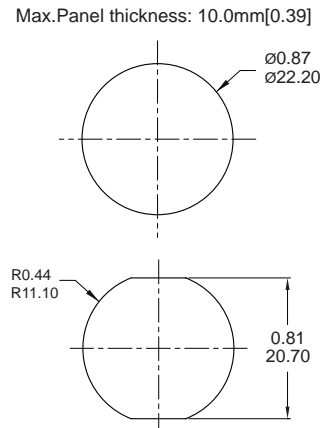

O-RING INSTALLATION

Proposal	In front of the panel	Behind the panel
Installation Diagram		

MPB22 Pushbutton Switches