

MPB19 Series

19mm Metal Pushbutton Switches



SPECIFICATIONS

RATING : 1th 5A/250VAC resistive load 3A/250VAC
CONTACT RESISTANCE : 50 mΩ max. @ 1A 12VDC (initial value)
INSULATION RESISTANCE : 1,000 MΩ min. at 500VDC
DIELECTRIC STRENGTH : 2,000V RMS @ sea level
OPERATION TEMPERATURE : -20°C to 55°C
MECHANICAL LIFE : Momentary 1,000,000 cycles
 Self-lock 500,000 cycles
ELECTRICAL LIFE : 50,000 make-and-break cycles at full load
TORQUE : 5~14Nm
PANEL THICKNESS : 10mm (Ø19.20mm)
OPERATION PRESSURE : 1Pole 2.5±1N / 2Poles 3.5±1N
TRAVEL : About 3.2mm
INGRESS PROTECTION : IP67, IK10(Stainless)

MATERIALS

BUSHING : Stainless Steel / Nickel plated brass
 / Aluminum alloy
BASE : PBT(UL 94-V0) , PC(UL 94-V2)
ACTUATOR : PC(UL 94-V2) ; Stainless Steel
 / Nickel plated brass / Aluminum alloy
INNER ASSEMBLY : POM / PA66.
SPRING : Spring steel.
SEALING : Silicone.
O-Ring : Silicone.
TERMINAL / CONTACT : Copper ,Silver plated.
HEX NUT : Nickel plated brass.

HOW TO ORDER



MODEL NO. BODY TYPE BUTTON TYPE CONTACT CONFIGURATION OPERATING TYPE LIGHT TYPE LED COLOR LED VOLTAGE TERMINAL SHAPE TERMINAL PLATING

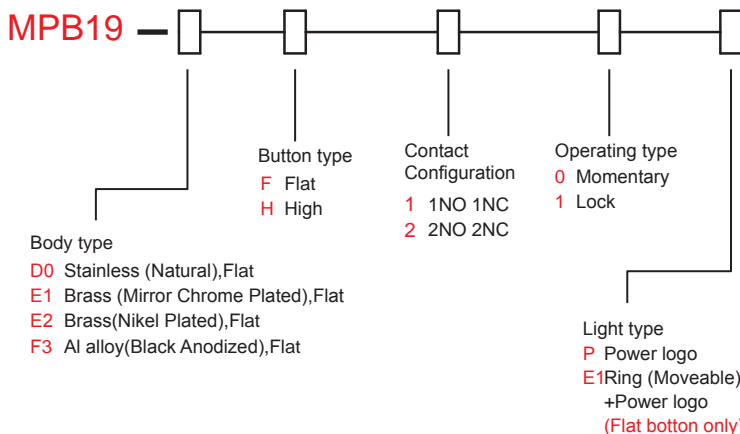
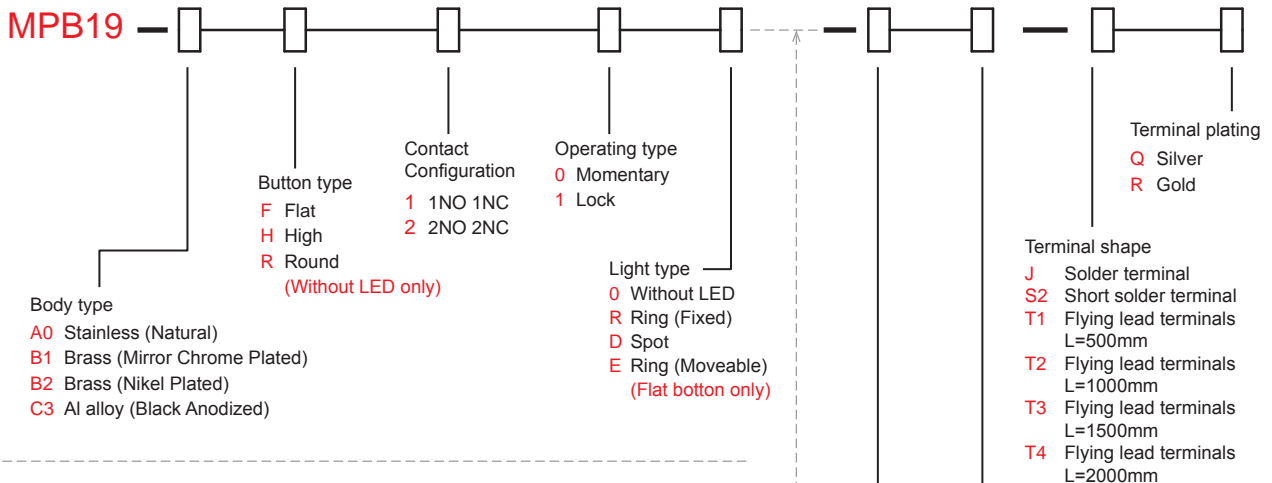

ITEM NO	COLOR
0	Without LED
1	White
3	Red
5	Yellow
6	Green
7	Blue
DUAL COLOR LED	
A	Red&Green
B	Red&Blue
D	Blue&Yellow
G	Red&Yellow
H	Green&Yellow
J	Orange&Green

ITEM NO	VOLTAGE
0	Without LED
3	3V
6	6V
12	12V
24	24V
36	36V
110	110V
220	220V

EXAMPLE:
 MPB19-A0F100-JQ (Without LED)
 MPB19-A0F10R- [] - [] - JQ
 LED color — LED voltage

MPB19 19mm Metal Switches

MPB19 Series

19mm Metal Pushbutton Switches

CIRCUIT

POSITION 1

POSITION 2



Without LED (1 Pole)

POSITION 1

POSITION 2

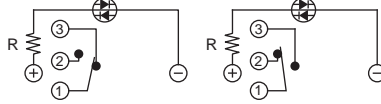

Single Color Led (1 Pole)

POSITION 1

POSITION 2

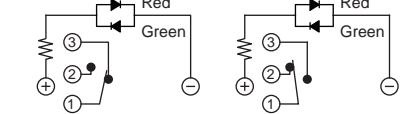

Dua Color Led (1 Pole)

POSITION 1

POSITION 2

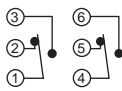
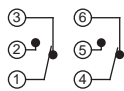

Without LED (2 Poles)

POSITION 1

POSITION 2

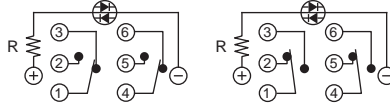

Single Color Led (2 Poles)

POSITION 1

POSITION 2

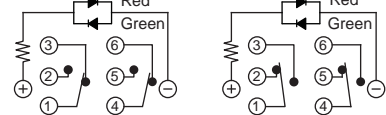

Dua Color Led (2 Poles)

BODY TYPE

A0/B1/B2/C3 Body

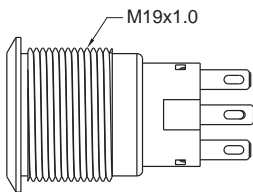

D0/E1/E2/F3 Body (Flat)

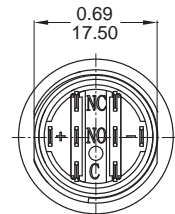
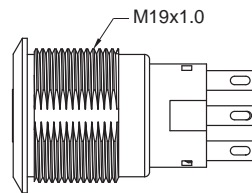
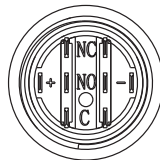

BUTTON TYPE

F Flat Button

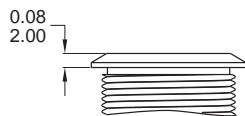

H High Button

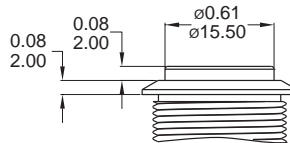

R Round Button

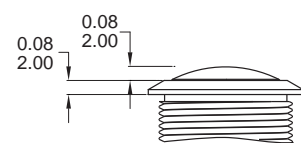

LIGHT TYPE

O Without LED

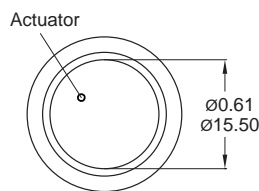

R Ring (Fixed)

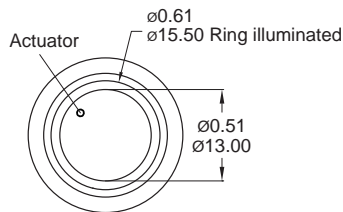

D Spot

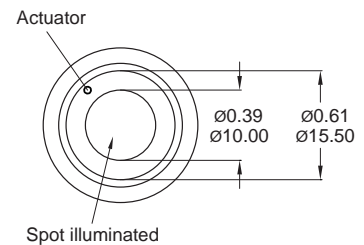

E Ring (Moveable)

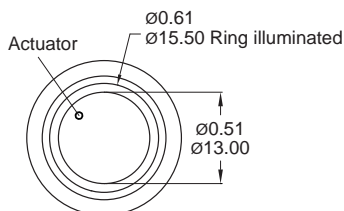

P Power logo

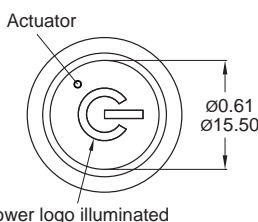

E1 Ring (Moveable)+Power logo

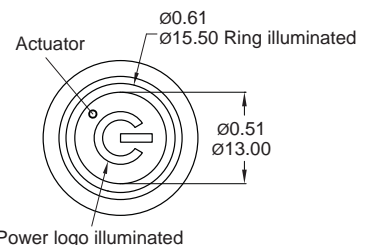

* Only for A0,B1,B2,C3 body.

* Only for D0,E1,E2,F3 body.

* E1 light type only for D0,E1,E2,F3 body.

FLAT BUTTON TYPE

0 Without LED

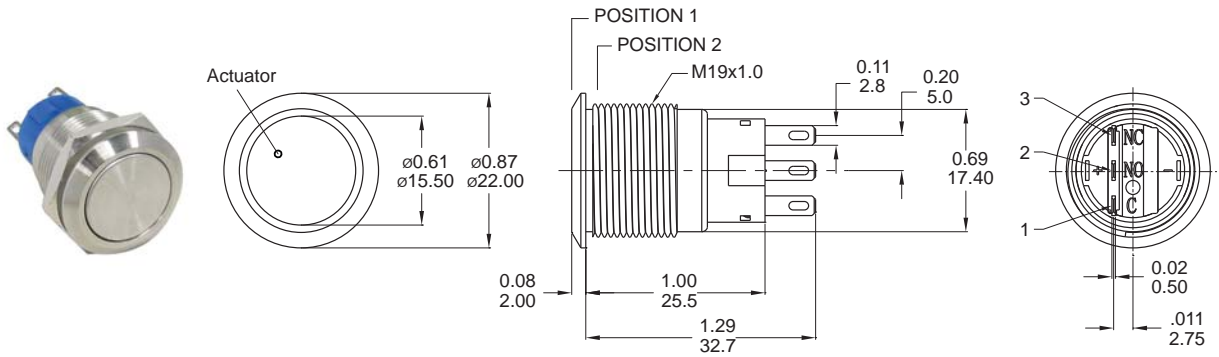

Part No. Shown : MPB19-A0F1□0-JQ

R Ring (Fixed)

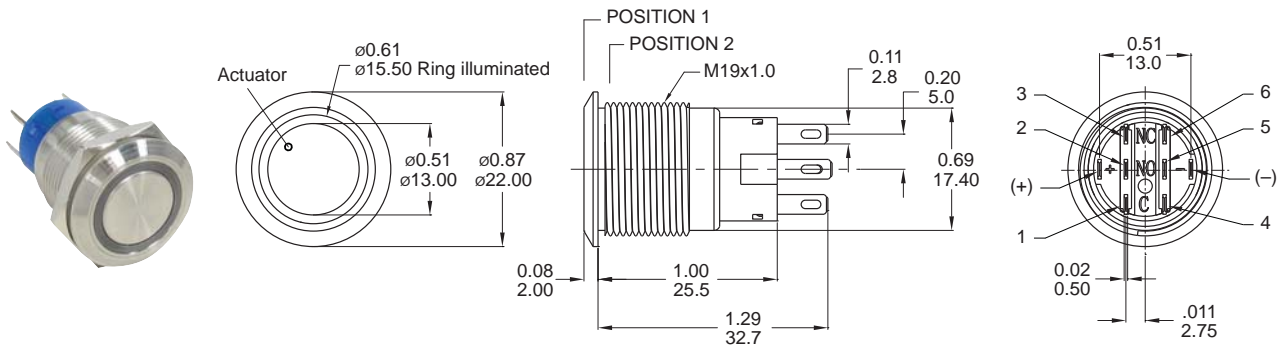

Part No. Shown : MPB19-A0F2□R-□□-JQ

D Spot

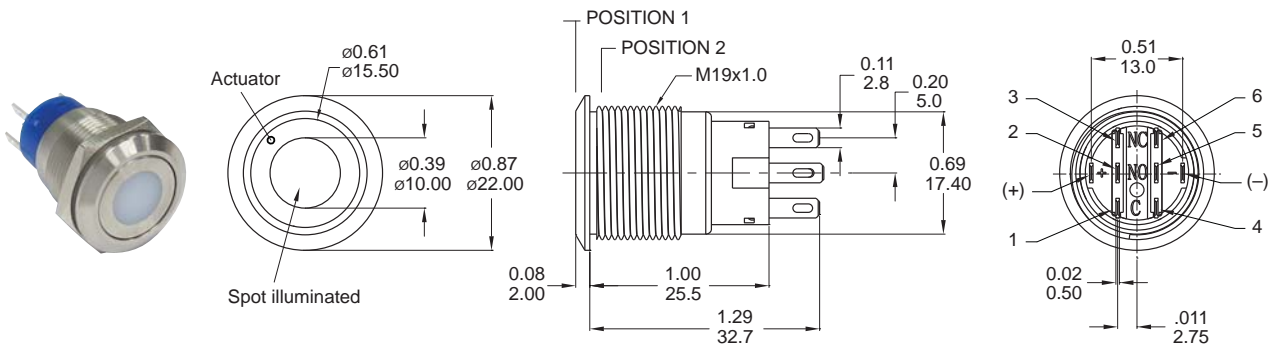

Part No. Shown : MPB19-A0F2□D-□□-JQ

E1 Ring (Moveable)+Power logo
(Flat Button only)

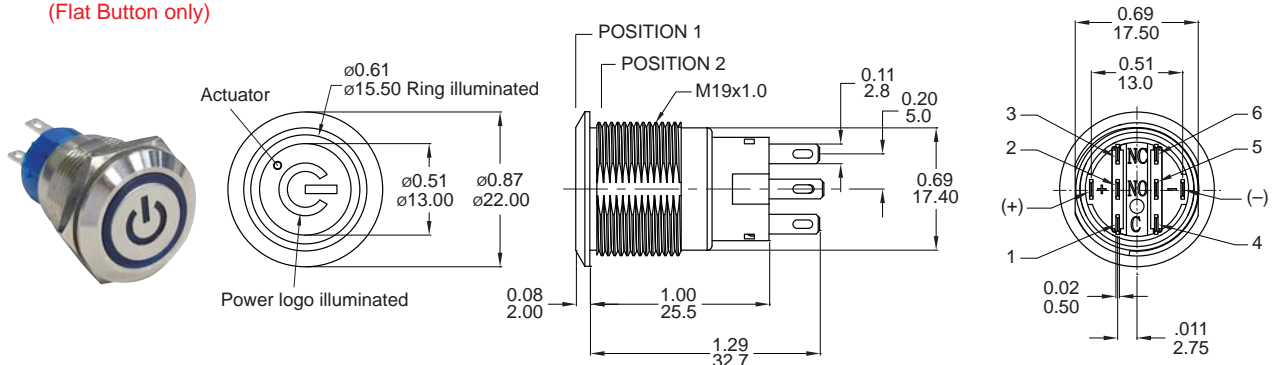

Part No. Shown : MPB19-D0F2□E1-□□-JQ



MPB19 Series

19mm Metal Pushbutton Switches

HIGH BUTTON TYPE

O Without LED

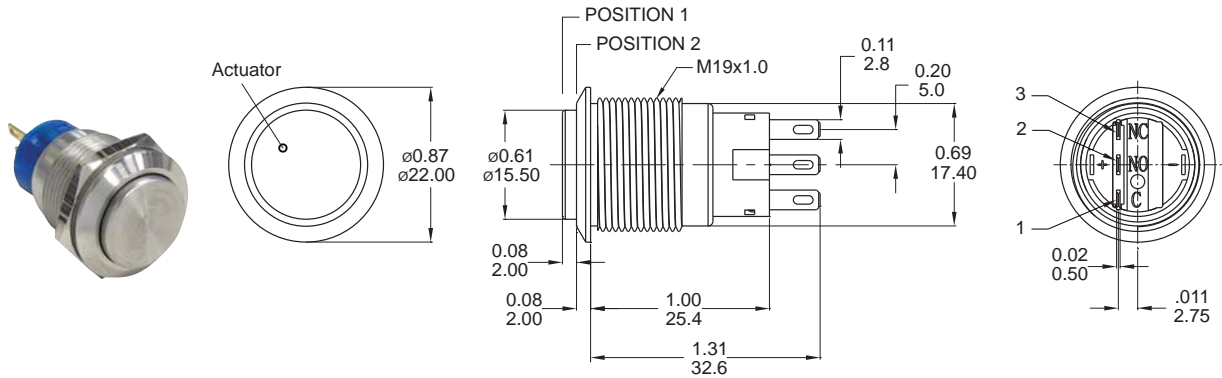

Part No. Shown : MPB19-A0H1□0-JQ

R Ring (Fixed)

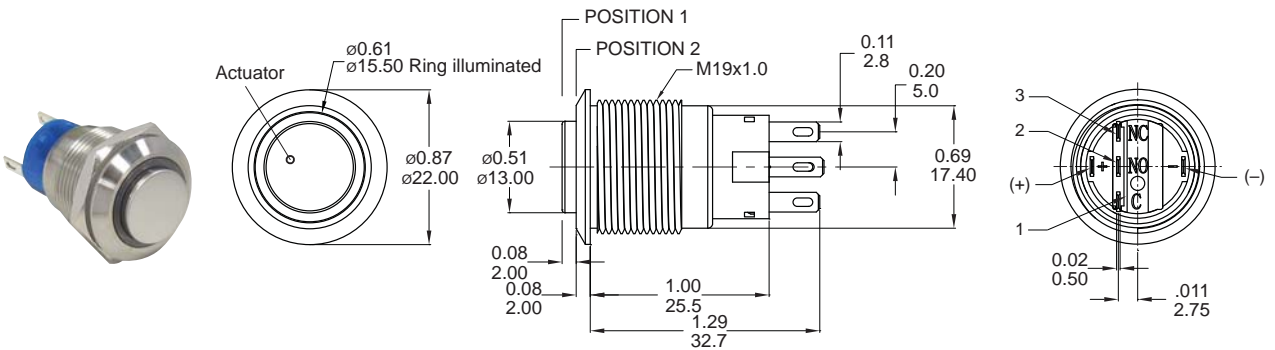

Part No. Shown : MPB19-A0H1□R-□□-JQ

P Power logo

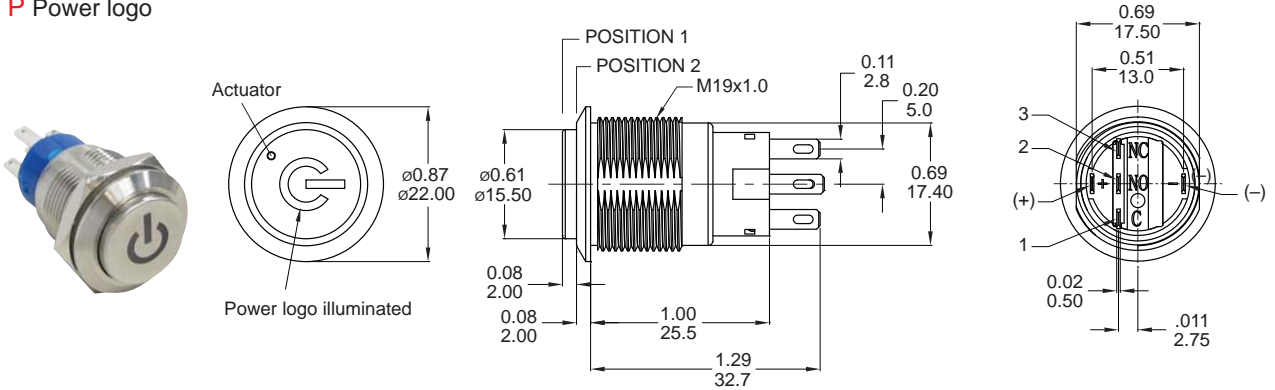

Part No. Shown : MPB19-D0H1□P-□□-JQ

ROUND BUTTON TYPE

O Without LED only

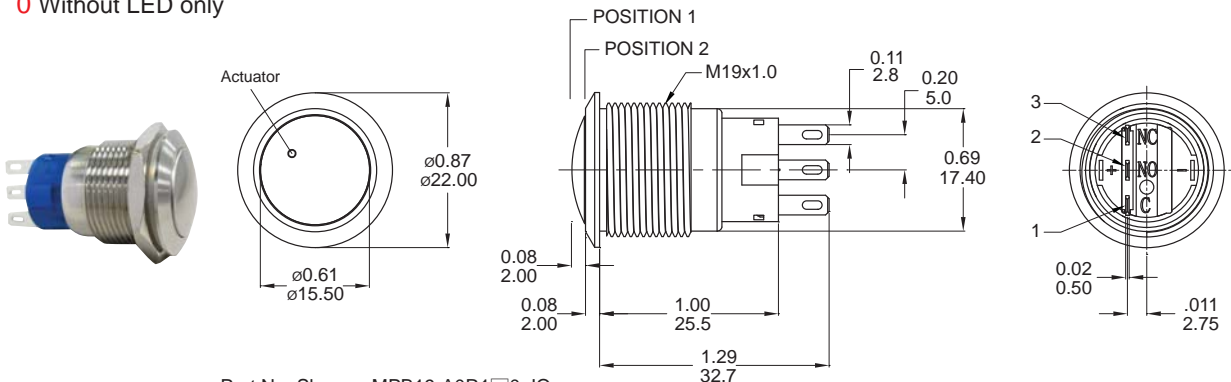

Part No. Shown : MPB19-A0R1□0-JQ

MPB19 Pushbutton Switches

TERMINAL TYPE

J Solder terminal (std)

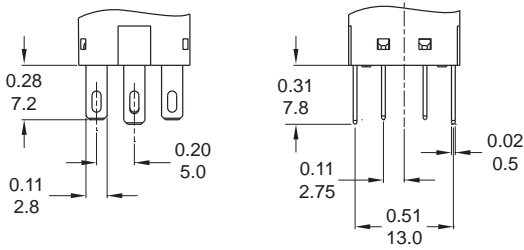

S2 Short solder terminal

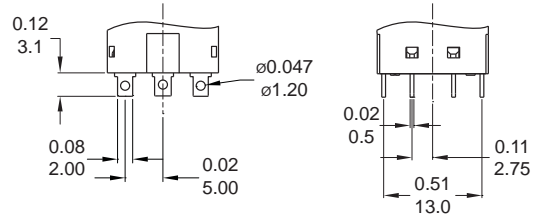

Wire (Flying lead Terminals)

※ Wire=UL 3385,18AWG,300V(Black/Yellow/Green/Red/Purple)

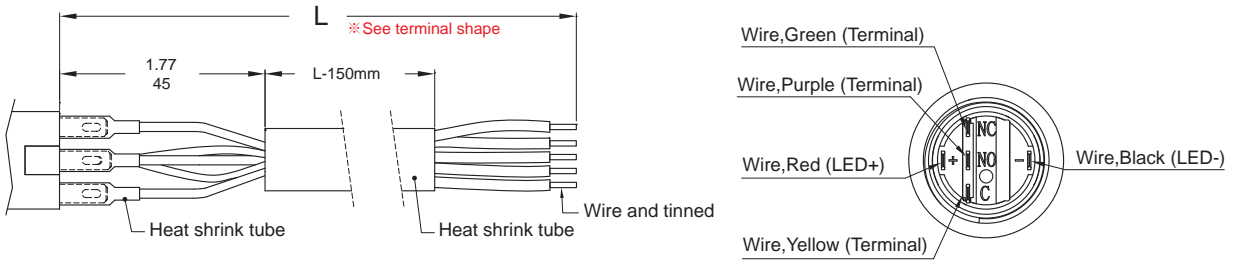

O/R/D/E Light Type

P Light Type

PANEL MOUNTING

Max. Panel thickness: 10.0mm[0.39]

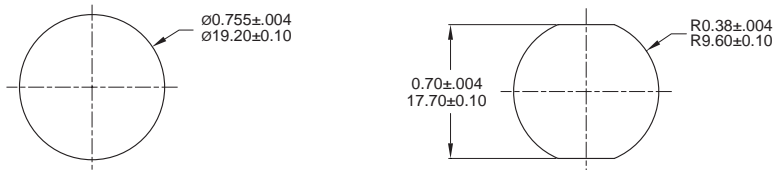

ASSEMBLED VIEW

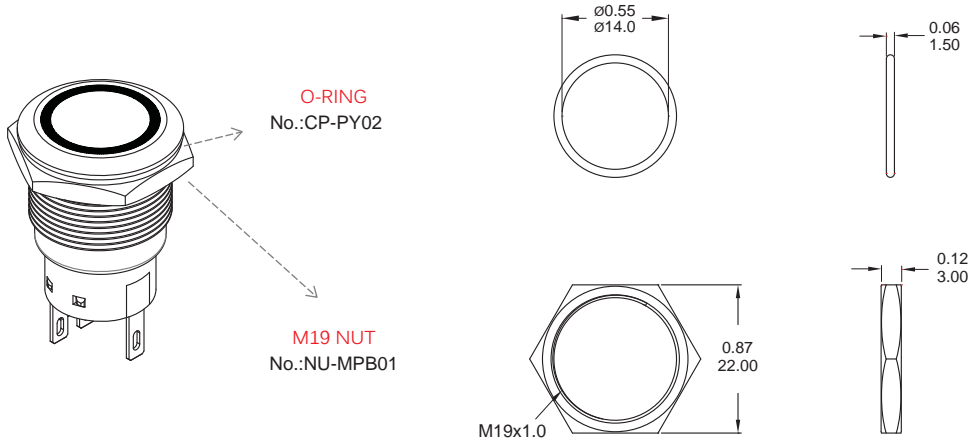

O-RING INSTALLATION

Proposal	In front of the panel	Behind the panel
Installation Diagram		

