



yeswitch

Navigation Switches Series SNA4



General Specifications

| | |
|---------------------------------|-------------------------|
| Current Rating | :50mA |
| Voltage Rating | :12VDC |
| Dielectric Withstanding Voltage | :250VAC for 1 minute |
| Contact Resistance | :100m Ohm Max.(initial) |
| Insulation Resistance | :100M Ohm Min. |
| Operating Force | :200gf ± 50gf |
| Total Travel | :0.25mm ± 0.1mm |
| Operating Life | :100,000 cycles Min. |
| Solder Specifications | :260 deg. for 3 seconds |
| Function | :SP5T |
| Operating Temperature | :-10 deg.~+60 deg. |

Materials

| | |
|-------------|-----------------------------------|
| Cap | :Polycarbonate (PC) |
| Housing | :Polyamide (PA) |
| Stem | :Polybutylene terephthalate (PBT) |
| Base | :Polyamide(PA) |
| Terminal | :Brass with silver plating |
| Action Dome | :SUS with gold plating |
| Connector | :PA , Brass with Tin plating |

Contact Configuration

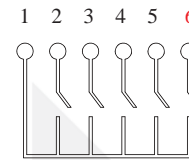

| Pin | Function |
|-----|-----------|
| 1 | SW COM. |
| 2 | SW 1 N.O. |
| 3 | SW 2 N.O. |
| 4 | SW 3 N.O. |
| 5 | SW 4 N.O. |
| 6 | SW 5 N.O. |

SW Configuration

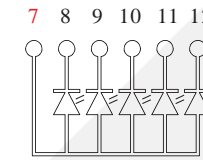

| Pin | Function |
|-----|-------------|
| 7 | LED + |
| 8 | SW 1 LED(-) |
| 9 | SW 2 LED(-) |
| 10 | SW 3 LED(-) |
| 11 | SW 4 LED(-) |
| 12 | SW 5 LED(-) |

LED Configuration

Installation Notes

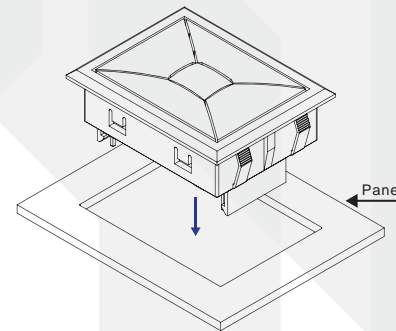

for SNA4S

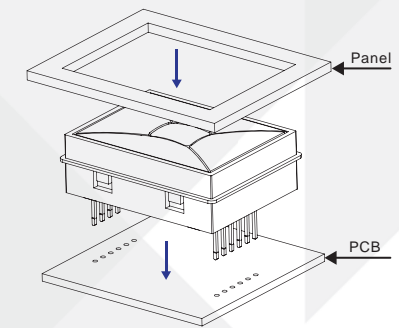

for SNA4P



yeswitch

Navigation Switches Series SNA4

Dimension / Panel Cutting of SNA4S

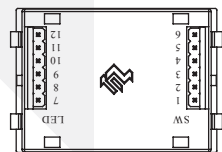
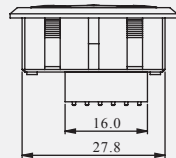
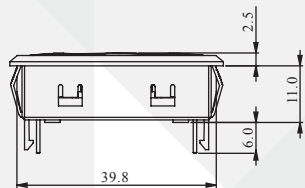
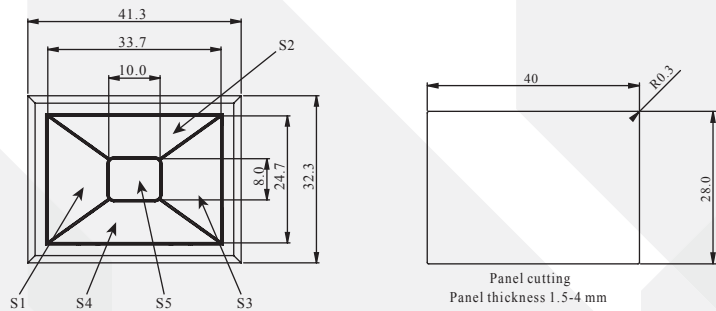

The Connector for SNA4 module similar JST RE-H(06)2TD
 Applicable Connector:
 Conductor pitch / 2.54mm
 Conductor width / \square 0.64mm

Dimension / Panel Cutting / PCB Layout SNA4P

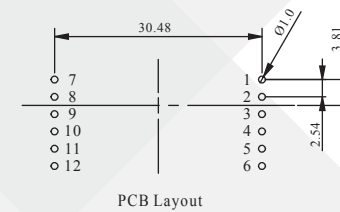
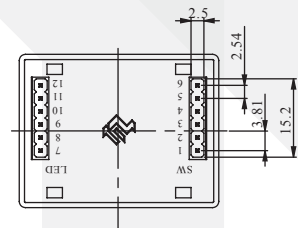
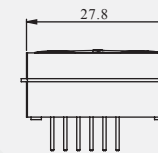
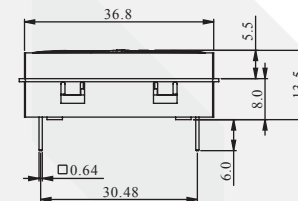
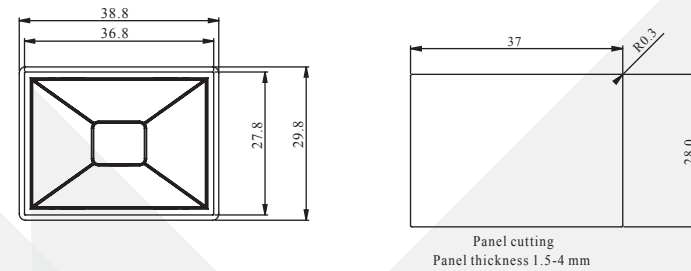



PCB Layout



yeswitch

Navigation Switches Series SNA4

How to order

| | | |
|-------------|---|---|
| Module |  |  |
| Part No | SNA4P1441 | SNA4S2551 |
| Description | Red LED, White housing, White cap, Marking 1. | Yellow LED, Black housing, Black cap, Marking 1. |

- ※ Color is subject to actual product.
- ※ We provide Marking service.

Option

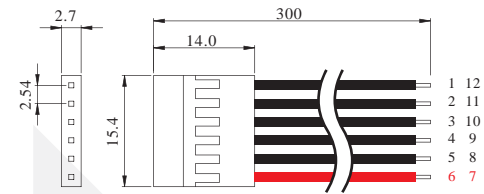

Cable: YCW012