

### SPECIFICATIONS

**CONTACT RATING:** Dependent upon contact material See Page 120.

**MECHANICAL LIFE:** 50,000 make-and-break cycles.

**CONTACT RESISTANCE:** 20 mΩ max. initial @ 2-4VDC  
100mA for both silver and gold plated contacts.

**INSULATION RESISTANCE:** 1,000 MΩ min.

**DIELECTRIC STRENGTH:** 1,000 Vrms min. @ sea level.

**OPERATING TEMPERATURE:** -30°C to 85°C.

### MATERIALS

**CASE:** Diallyl phthalate(DAP) (UL94V-0).

**PLUNGER:** Nylon 6/6, black.

**BUSHING:** Brass or zinc, nickel plated.

**HOUSING:** Stainless Steel.

**SWITCH SUPPORT:** Brass, tin plated.

**CONTACT/TERMINAL:** Copper alloy or Brass, with silver or gold plated. (See Page 120)

## HOW TO ORDER

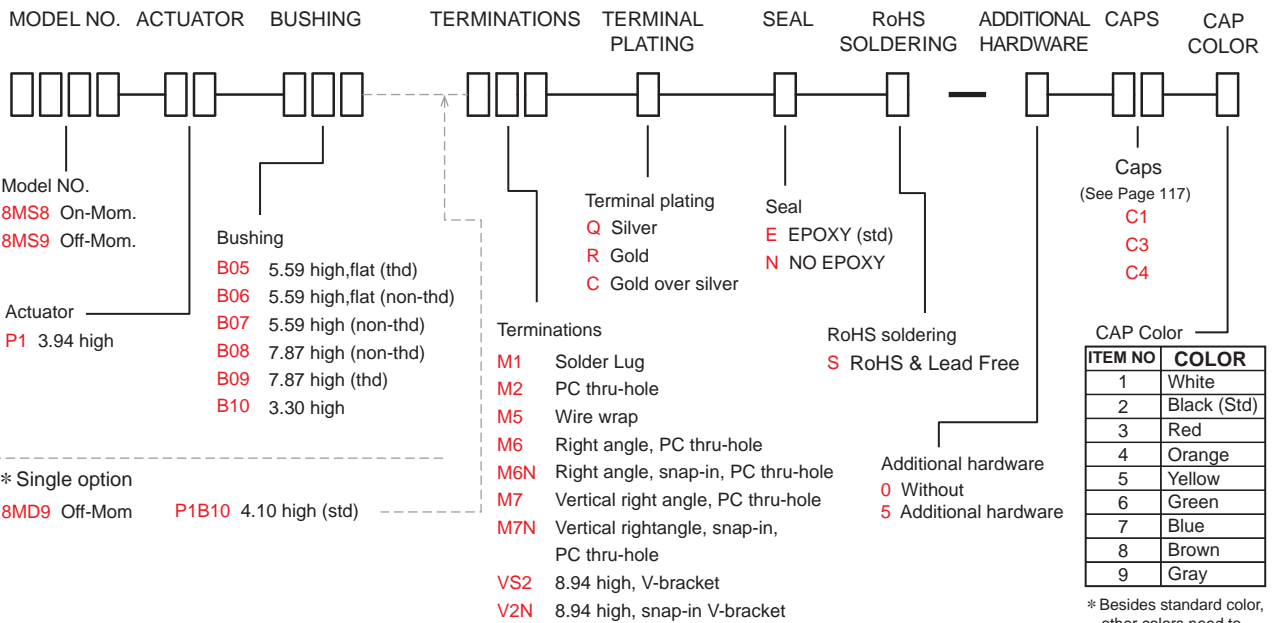

\* Besides standard color, other colors need to check stocks available.

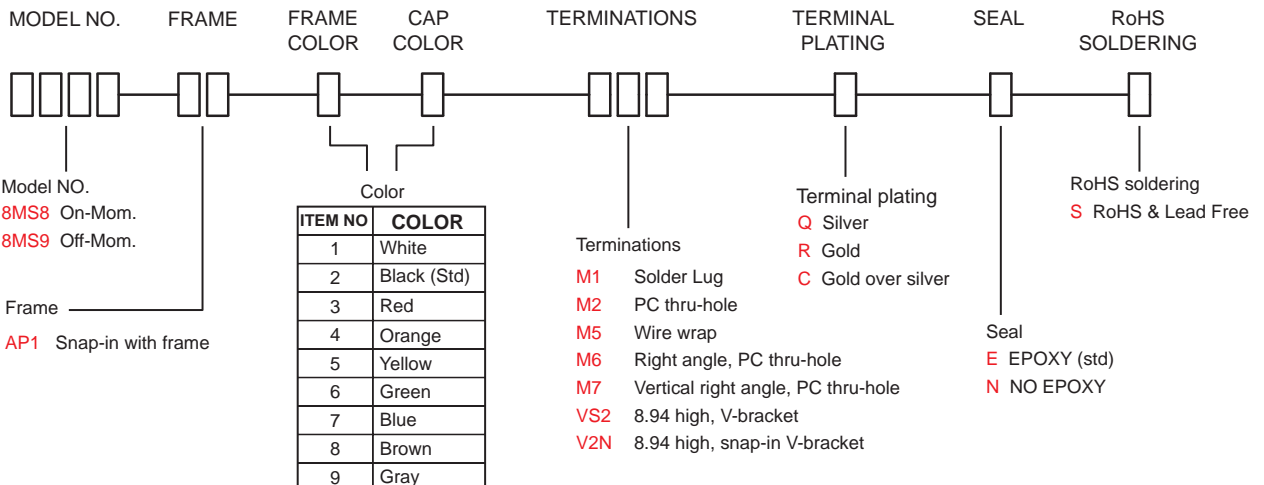

\* Besides standard color, other colors need to check stocks available.

# 8M Series

Sub-Miniature Pushbutton Switches

## SWITCH FUNCTION

NO. POLES	UL/CSA MODEL NO.	MODEL NO.	SWITCH FUNCTION		CONNECTED TERMINALS / SCHEMATIC	
			POS.1	POS.2	POS.1	POS.2
SP	Q2818	8MS8	ON	MOM	2-1 	2-3 
	Q2819	8MS9	OFF	MOM	OPEN	1-3 
DP	Q2829	8MD9	OFF	MOM	OPEN	1-3,4-6 

MOM=MOMENTARY

## POLE OPTIONS

8M Pushbutton Switches

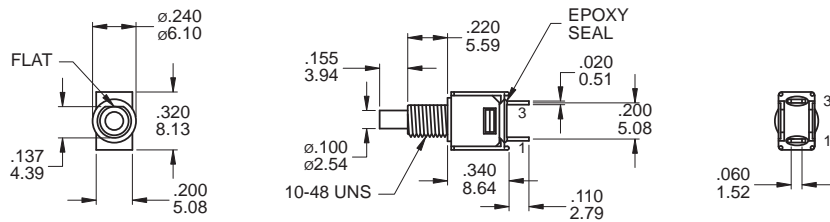

**SPST**

Part No. Shown : 8MS9P1B05M1QE

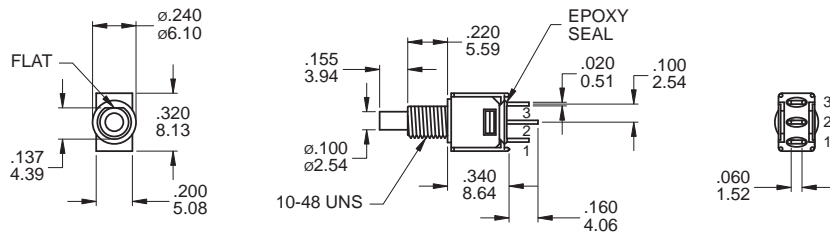

**SPDT**

Part No. Shown : 8MS8P1B05M1QE

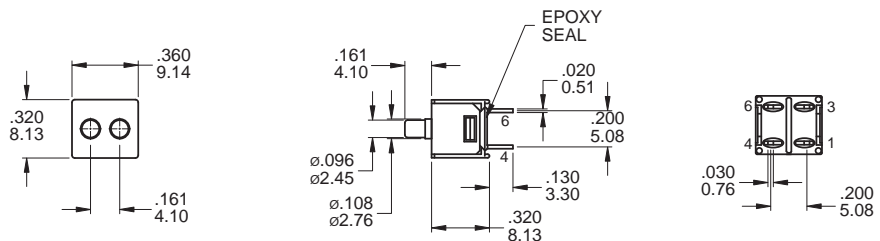

**DPST**

Part No. Shown : 8MD9P1B10M2RE

## BUSHING OPTIONS

**B05 THD**

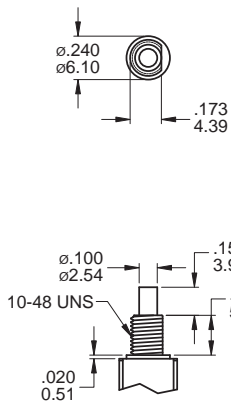

**B06 NON-THD**

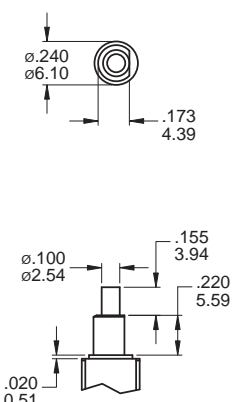

**B07 NON-THD**

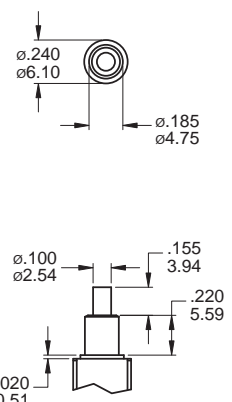

**B08 NON-THD**

**B09 THD**

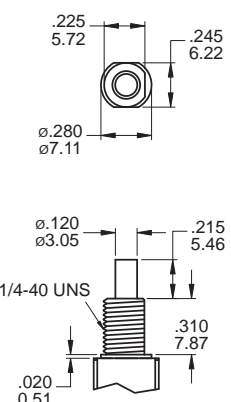

**B10**

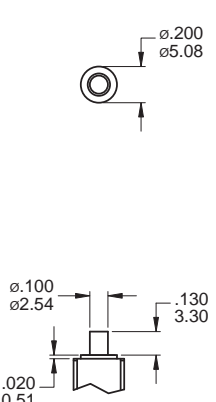

8M Pushbutton Switches

## TERMINATION OPTIONS

**M1 Solder lug**

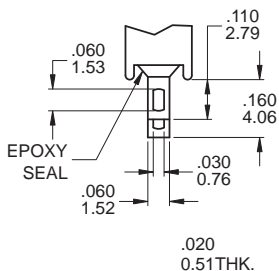

**M2 PC Thru-hole**

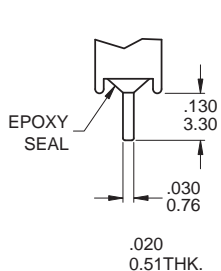

**M5 Wire Wrap**

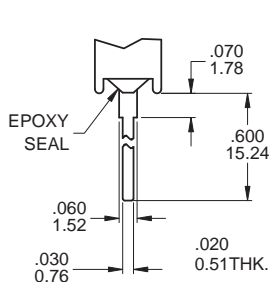

### OTHER TERMINATION OPTIONS

- M6** Right angle P.C. Mount
- M6N** Right angle P.C. Mount with snap-in bracket
- M7** Right angle P.C. Mount
- M7N** Right angle P.C. Mount with snap-in bracket
- VS2** Right angle P.C. Mount
- V2N** Vertical bracket P.C. Mount with snap-in bracket

**M6**

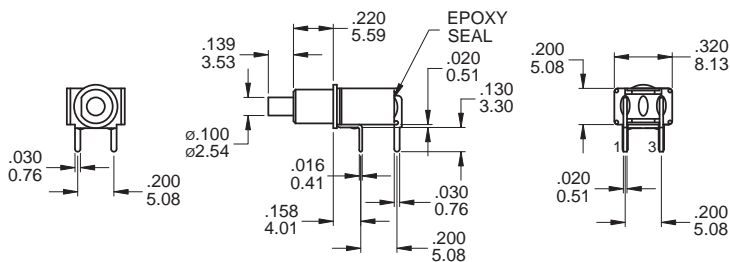

### P.C. MOUNTING

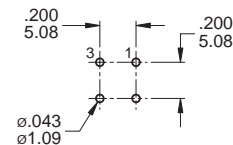

**SPST**

Part No. Shown : 8MS9P1B06M6RE

**M6**

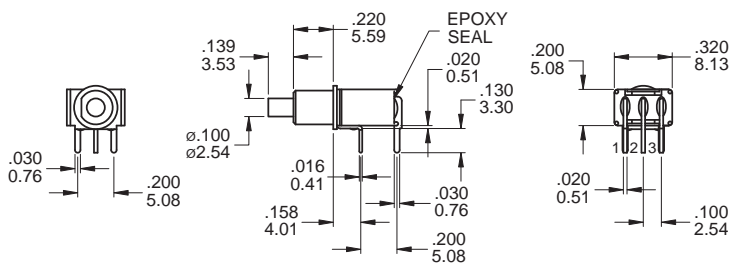

### P.C. MOUNTING

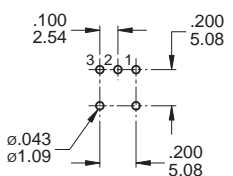

**SPDT**

Part No. Shown : 8MS8P1B06M6QE

# 8M Series

Sub-Miniature Pushbutton Switches

M6

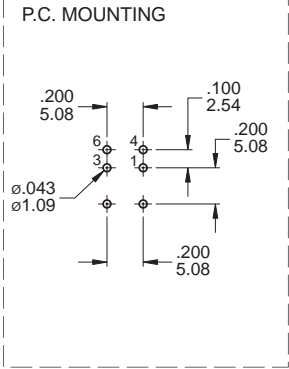
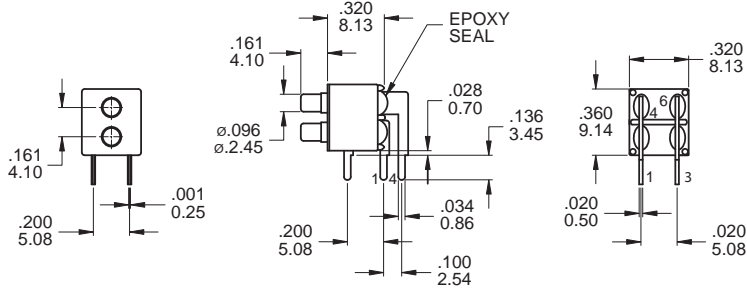

DPST

Part No. Shown : 8MD9P1B10M6RE

M7

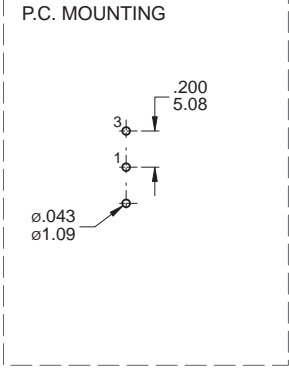
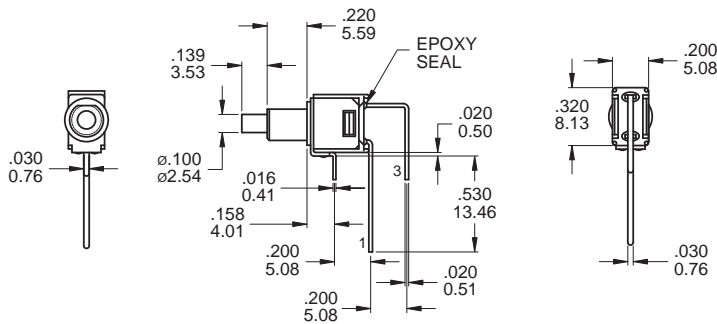

SPST

Part No. Shown : 8MS9P1B06M7QE

M7

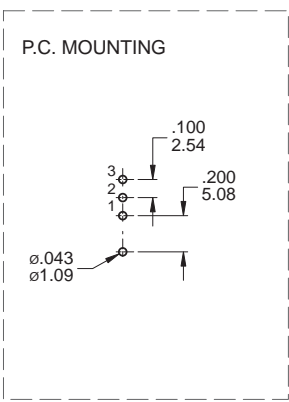
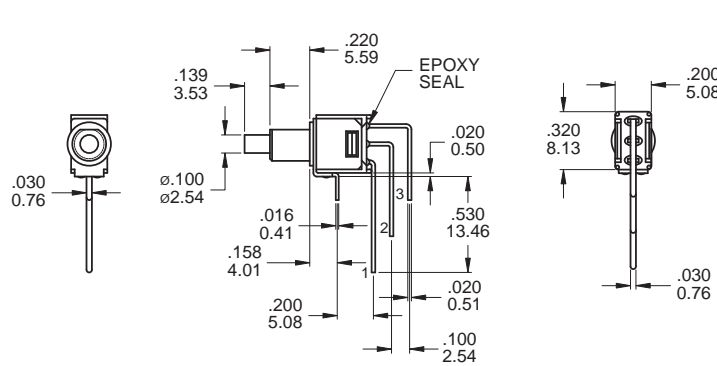

SPDT

Part No. Shown : 8MS8P1B06M7QE

VS2

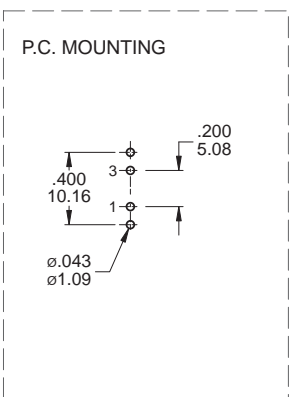
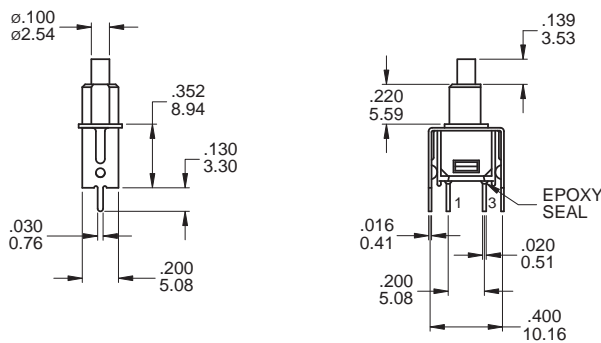

SPST

Part No. Shown : 8MS9P1B06VS2QE

8M Pushbutton Switches

## VS2

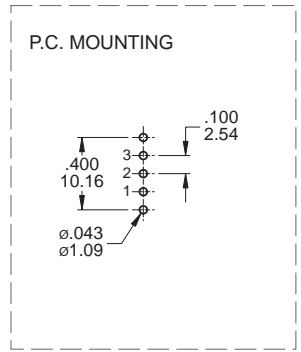
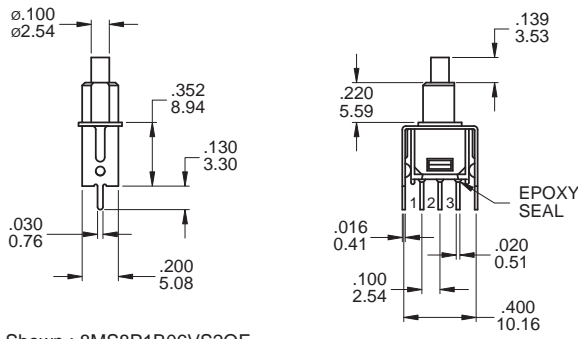

## SPDT

Part No. Shown : 8MS8P1B06VS2QE

## AP1

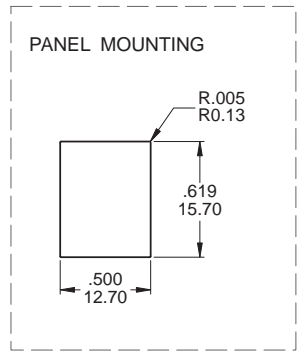
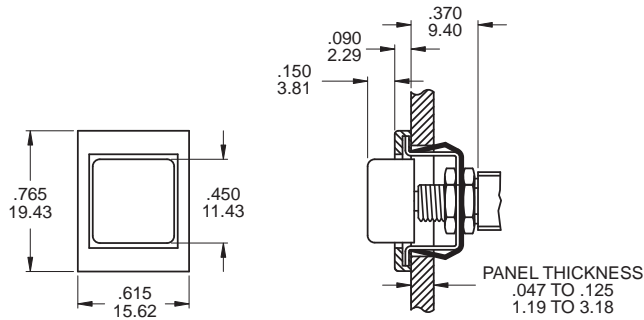

## SPST

Part No. Shown : 8MS9AP122M1QE

### SNAP-IN TERMINATION OPTIONS

#### M6N

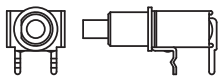

#### M7N

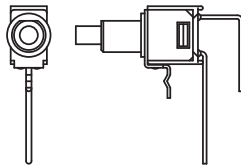

#### V2N

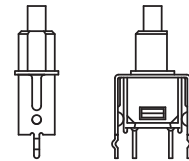

### CAP OPTIONS

#### C1 For 8M Series ONLY

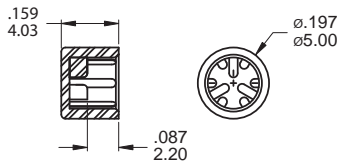

#### C2 For 8A,8B Series ONLY

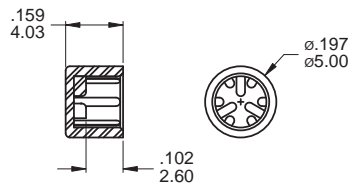

#### C3 For 8M Series B8,B9 Bushing ONLY

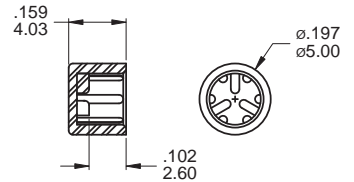

#### C4 For 8M Series ONLY

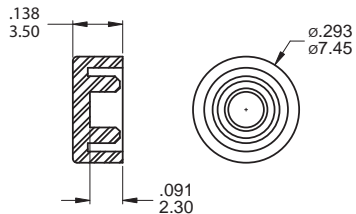

#### C5 For 8A,8B Series ONLY

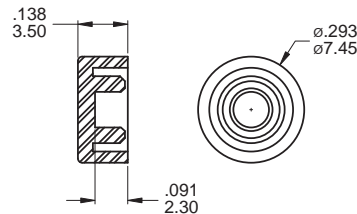

Cap Standard Color : White, Black, Red, Green

