



# 深圳市华浩德电子有限公司

Shenzhen Fahold Electronics CO.,LTd.

地址：深圳市宝安区石岩街道石龙社区石环路4号星光工业园C栋二、四、五、六楼

Add.:Floor 2,4,5, 6 Building C, Starlight Industrial Park, NO. 4, Shihuan Road,Shilong Community, Shiyan Town, Bao'an District, Shenzhen, China.

Product Name: 产品名称	FD-150G 系列防水电源					
Product Model: 产品型号	FD-150G-040/B/C/D	24-40V	2.5-4.7A	FCC <input checked="" type="checkbox"/>	UL <input checked="" type="checkbox"/>	
	FD-150G-050/B/C/D	30-50V	2.3-4.2A	FCC <input checked="" type="checkbox"/>	UL <input checked="" type="checkbox"/>	
	FD-150G-060/B/C/D	40-60V	2.0-3.6A	FCC <input checked="" type="checkbox"/>	UL <input checked="" type="checkbox"/>	
	FD-150G-082/B/C/D	50-82V	1.3-2.6A	FCC <input checked="" type="checkbox"/>	UL <input checked="" type="checkbox"/>	
	FD-150G-143/B/C/D	76-143V	0.7-1.3A	FCC <input checked="" type="checkbox"/>	UL <input checked="" type="checkbox"/>	

版本: REV.: 01



SIGNATURE AND SEAL BY US /我司签字盖章		
日期:	2018-06-16	
Prepared By 编制	Checked By 审核	Approved By 批准

Please confirm and send it back with signature within 7 days. Otherwise we will assume your acceptance. And if any quality dissent, will execute according to this product specification.

请确认后七日内回签，如不回签则视贵公司默认接受，在发生品质异常时按此份产品规格书执行。

CUSTOMER APPROVED SIGNATURE /客户承认盖章

Customer Model No. 客户型号:		
日期:		
ENG./工程	QA/品管	OTHER/其他

Comments 建议:



**Feature特征:**

- ◆ IP65防护等级
- ◆ Max output power 150W.最大输出功率150W
- ◆ Constant current design. 恒流设计
- ◆ 3 in 1 dimming mode:0-10V,PWM,RX. 三合一调光  
调光模式: 0-10v, PWM,RX
- ◆ Smoothly dimming(0-100%),can dim to off.  
从0%-100%平滑调光, 且调光输出可关断
- ◆ TUV CB CE UL FCC Certified.多个国家与机构认证
- ◆ PROTECTION: Short Circuit, Open Circuit  
保护: 短路保护, 开路保护
- ◆ Surge protection: 4KV.浪涌保护4KV

**Application应用**

- ◆ Street lights、High bay lights.路灯、工矿灯

**Introduction 介绍**

The document detail the electrical, mechanical and environmental specifications of a 150W constant current LED driver with 0(1)-10V Dimming. This LED drive power supply is suitable only for LED load.

此份资料详细描述了一款 150W 系列带 0-10V 调光的 LED 恒流驱动电源的电器性能, 环境性能等。此款电源只适用于 LED 负载。

**Model and Key parameters 型号和关键参数 Table 1, 表 1**

Model 型号	功率 (W)	Output volgag 输出 电压(V)	Max output voltage (Vdc)最大空载电压	output current 输出电流(A)	Efficiency 效率(%) @200V	Efficiency 效率(%) @480V
FD-150G-040 /B/C/D	150	24-40	40	2.50-5.00	89	90
FD-150G-050 /B/C/D	150	30-50	50	2.30-4.40	89	90
FD-150G-060 /B/C/D	150	40-60	56	2.00-3.80	90	91
FD-150G-082 /B/C/D	150	50-82	85	1.30-2.75	90	91
FD-150G-143 /B/C/D	150	76-143	145	0.70-1.30	90	91

Note:

1:带载最大电压测试 Max output voltage test

2: 可选字母 B,C,D 或空位, 表示输出增加不同的可选功能。默认空位表示可调电流 (基础机型);B 字母表示可三合一调光并可调电流, C 字母表示不可调光不可调电流, D 字母表示可三合一调光。

2: Optional letters B, C, D or empty, indicating that the output increases with different optional functions. The default position indicates that the current can be adjustable(basic model); letter B can be three-in-one dimming and fine-tuning current, letter C indicates that non dimmable and output current unadjustable, letter D refers to three-in-one dimming.

3:型号 C/D 后面标签上要写 YYY,YYY 代表输出电流, 如 FD-150V-42C-4400

The model C / D on the back of the label to write YYY and YYY for the output current, such as FD-150V-42C-4400



**■ Technical data 技术参数**

<b>Input characteristics 输入特性</b>	
Input Voltage 输入电压	200-480Vac
Input Frequency 输入频率	50/60Hz
Input Current (Typ.) 输入电流 (典型值)	0.8 A @200-480 Vac, 100% load
No load Voltage 空载功耗	2Wmax
Inrush Current 浪涌电流	60Amax. @ 200Vac, 25°C
Power factor (Typ.) 功率因数 (典型值)	PF>0.95 @ 200-347 Vac, 100% load, PF>0.92 @ 480Vac 100% load 见图 2
THD 总谐波失真	THD<15% @ 200-480 Vac, 100% load 见图 3
<b>Output characteristics 输出特性</b>	
Current accuracy 电流精度	± 5% I <sub>o</sub>
Efficiency 效率	≥89% @ 200 Vac, ≥90% @ 480 Vac, 见图 1
Output Voltage 输出电压	Table 1, 见表 1
Ripple and Noise 纹波与噪声	800mVp-p
Line Regulation 线性调整率	3% <sub>lo</sub>
Load Regulation 负载调整率	3% <sub>lo</sub>
Turn On Delay Time 开机延时	Under normal conditions, the maximum delay time is 2 second 最大延迟时间小于 2 秒
<b>Protection functions 保护功能</b>	
Open circuit 开路保护	When the LED disconnection the product is protected such as hiccup or when it is at the highest point of output voltage, the power supply shall be self-recovery when the fault condition is removed.当 LED 开路时, 产品进入保护状态, 如打嗝或钳在某输出最高电压状态, 产品不会损伤, 当故障排除或重新开机时, 电源恢复工作正常。
Short Circuit 短路保护	The input power shall decrease when the output rail short, the power supply shall be self-recovery when the fault condition is removed.当输出短路时输入功率会相应减小, 短路情况解除后, 电源自动恢复正常。
<b>Environmental conditions 环境条件</b>	
Operating Temperature 工作温度	-40°C to +60°C
Operating Relative Humidity 湿度	10% to 90% RH, non-condensing
Storage Temperature 储存温度	-40°C to +85°C
Storage Relative Humidity 储存湿度	10% to 90%RH, non-condensing (Sea level to 2,000 m)
Vibration 振动	10 to 500HZ Sweep at constant acceleration of 1.0G (depth: 3.5mm) for 1 Hour for each of the perpendicular axes X, Y, Z.
Degrees of Protection 防护等级	IP6
<b>Safety compliance 安全标准</b>	

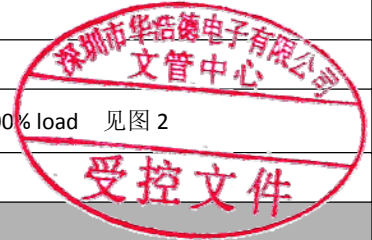

Safety Standard 安规标准	GB19510.1,GB19510.14;EN61347-1,EN61347-2-13;UL8750, CSA C22.2No.250.13-12.	
Dielectric Strength 介电强度	初级-次级: P-S:3750VAC/5mA/60S 次级-地: P-E:500VAC/5mA/60S	初级-地: P-E:1500VAC/5mA/60S
Insulation Resistance 绝缘电阻	I/P-O/P:>50M Ohms / 500VDC / 25°C / 70% RH.	
Leakage Current 泄漏电流	The leakage current shall be less than 0.25mA for Class 2 at maximum input voltage	
EMI	GB17743, GB17625.1; EN55015, EN61000-3-2, EN61000-3-3, FCC Class B.	
EMS	EN 61000-4-2, 3,4,5,6,8,11, EN 61547.	
ESD 静电放电(静电) 免疫	静电放电/免疫 Severity Level 等级 Level3/3 级 空气放电: ±8KV Severity Level 等级 Level2/2 级 接触放电: ±15KV 性能标准: C	
RF 射频场强度	射频电磁场药敏试验, 80-1000MHZ; Severity Level 等级: Level2/2 级, 3V/M; Performance Criterion 性能标准: A	
EFT 电快速瞬变脉冲	Severity Level 等级: Level2/2 级 line to line 1.0kv	性能标准: B
Surge Immunity 浪涌雷击	Severity Level 等级: Level2/2 级, 差模 4kV Severity Level 等级: Level3/3 级, 共模 4KV Performance Criterion 性能标准: B	
<b>Reliability 可靠性</b>		
Life Time 寿命	≥5Years H@347Vac, 100% load. See lifetime vs. Tc curve for the details	
MTBF 平均无故障时间	≥ 200,000H@ 25°C,480Vac, 80% load. (MIL-HDBK-217F)	
Warranty 质保	5 years	
<b>Others 其它</b>		
Dimensions 尺寸	150*150*77mm (L*W*H)	
Weight 重量	1460±10g	
<b>Remark 备注</b>		
1. The parameters above including the power factor, THD, efficiency are all tested under the ambient temperature 25°C and humidity 50%, AC input 347V and 90% output load.此参数所得包括功率因数, 总谐波失真, 效率等所有测试均在 25°C 50%湿度 输入电压 347V 以及 90%输出负载的环境下测试。		
2. I <sub>o</sub> is rate output current.		

**■ Dimmable 调光功能**

调光类型	参数	Min 最小值	Typ 典型值	Max 最大	备注
0-10V 1-10V	信号电平	-20V	0-10V	14V	
	调光范围	10%		100%	输出电流百分比
	开启电平	0.3V	0.5V	0.7V	
	关断电平	0.5V	0.7V	0.9V	
PWM	信号电平	0V	10Vp-p	14V	
	信号频率	200Hz		2KHz	
	占空比	5%		100%	
电阻调光	电阻值	0.4kΩ		50kΩ	
	调光范围	10%		100%	输出电流百分比

### ■ Dimmable 调光范围

Function			0-10V			PWM			RX			
Yes Or No			Y			Y			Y			
0-10V	0	1	2	3	4	5	6	7	8	9	10	open
Ir	0	11%	22%	31%	41%	51%	61%	71%	81%	91%	100%	100%
PWM	0	10%	20%	30%	40%	50%	60%	70%	80%	90%	100%	100%
Ir	0	9%	19%	29%	39%	49%	59%	69%	80%	90%	100%	100%
RX	0	0.4K Ω	0.8K Ω	1.4K Ω	2.2K Ω	3.2K Ω	4.3K Ω	6.3K Ω	9.6K Ω	16.2K Ω	45K Ω	50KΩ
Ir	0	10%	20%	30%	40%	50%	60%	70%	80%	90%	100%	100%

Note:

1. Ir is the output current percentages. Ir 为输出电流百分比
2. Ir above is typical values. 以上 Ir 均为典型值

### ■ Efficiency vs. Load 效率负载

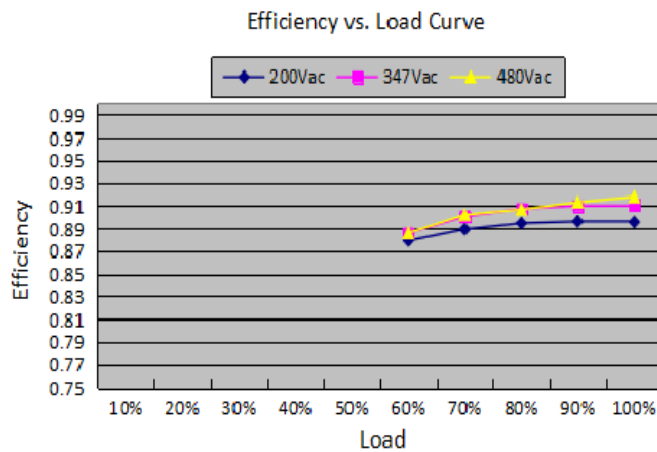

### ■ Power Factor 功率因素

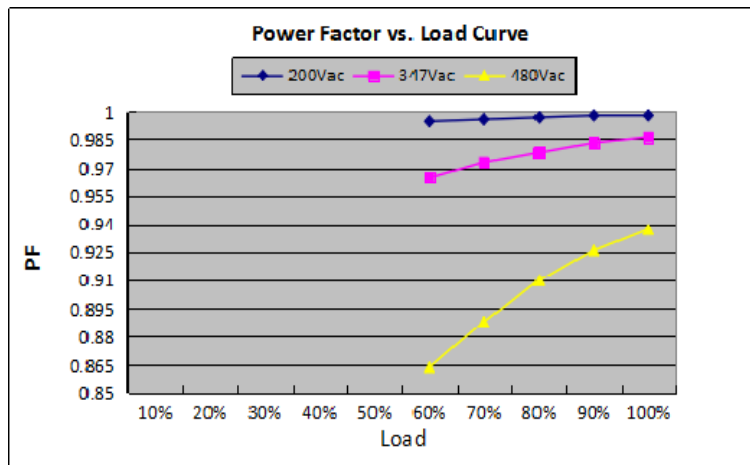

### THD vs. Load THD 和负载

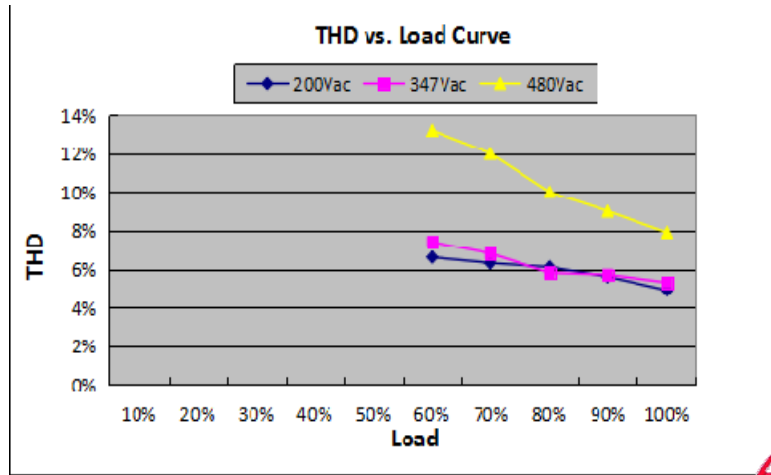

### Dimming 调光曲线 P4, 图 4

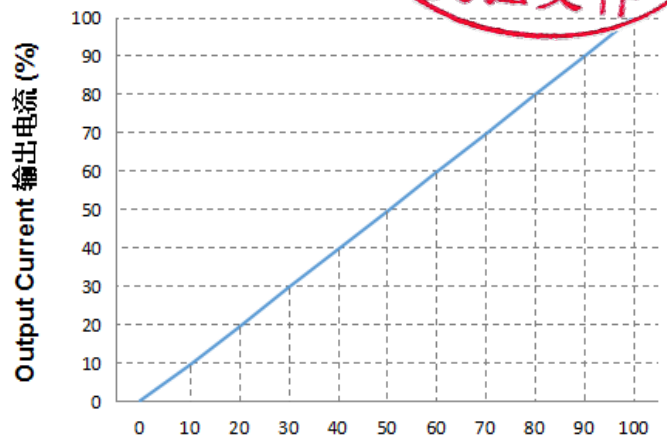
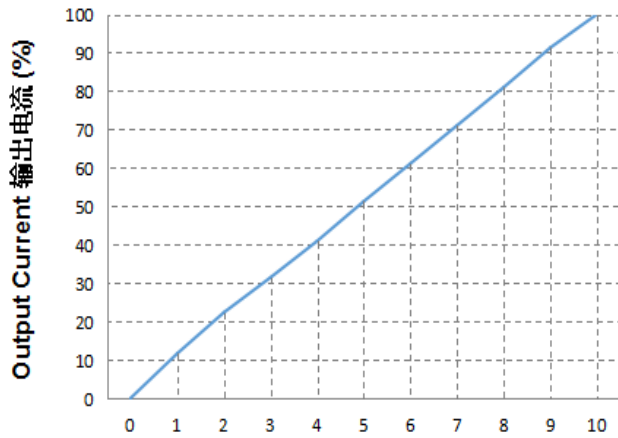

Dimming Voltage 调光电压 (V)

PWM Duty 调光比例 (%)

### Life vs. Tc 寿命和温度 P5, 图 5

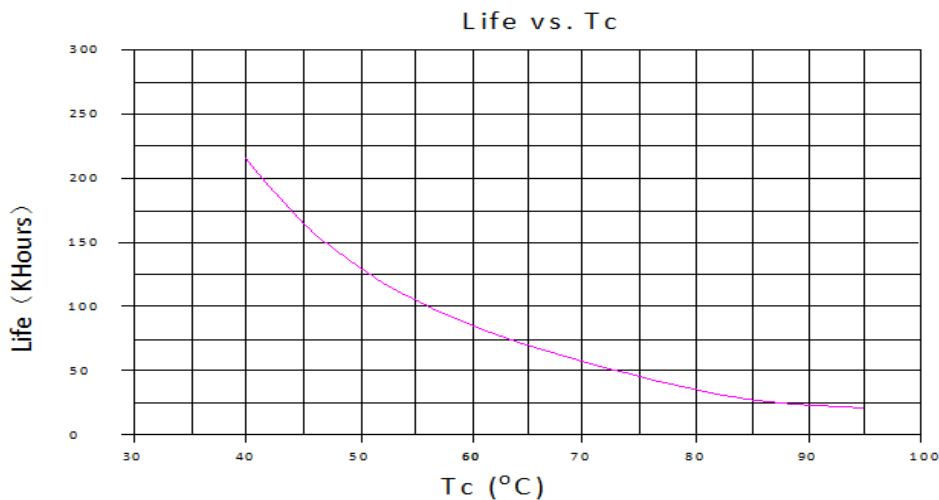



■ Output Voltage vs. Output Current 输出电压和电流范围 P6, 图 6

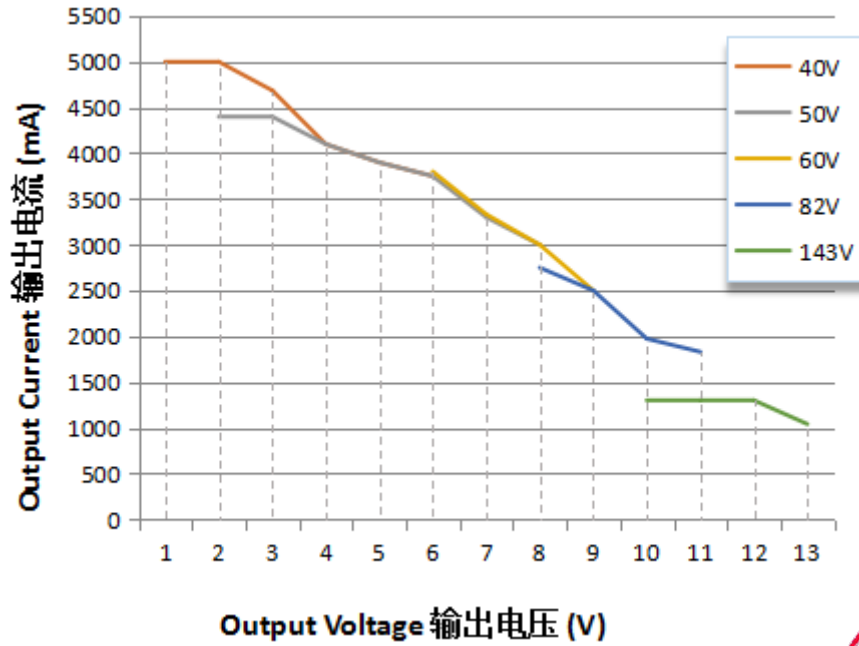

■ 接线图

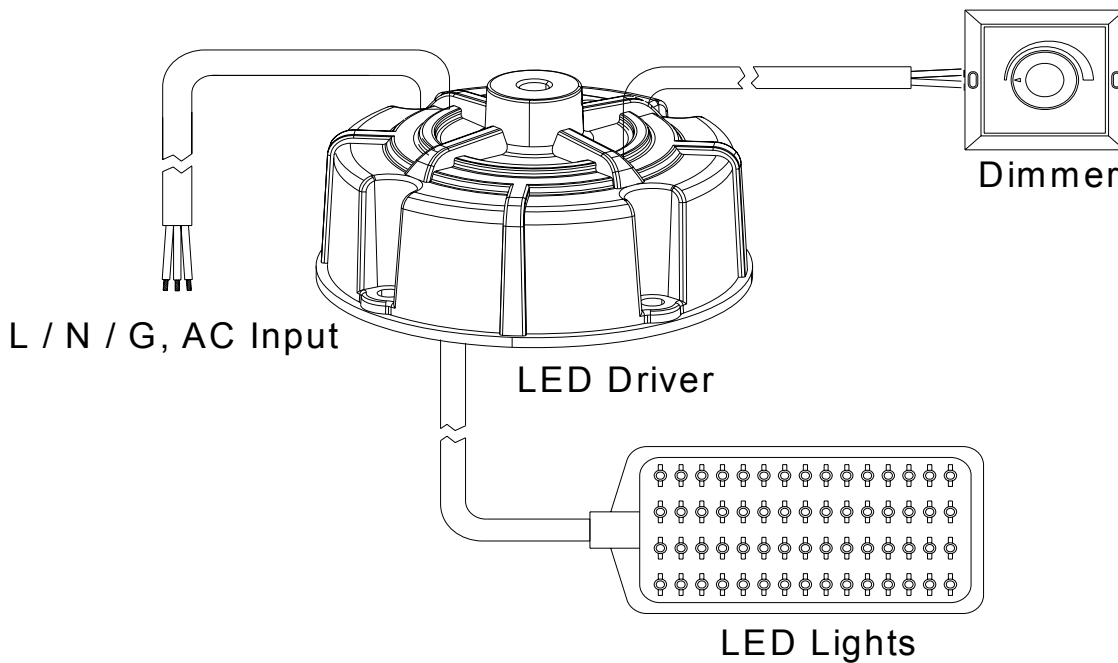



### Dimensional Drawing (unit: mm)尺寸

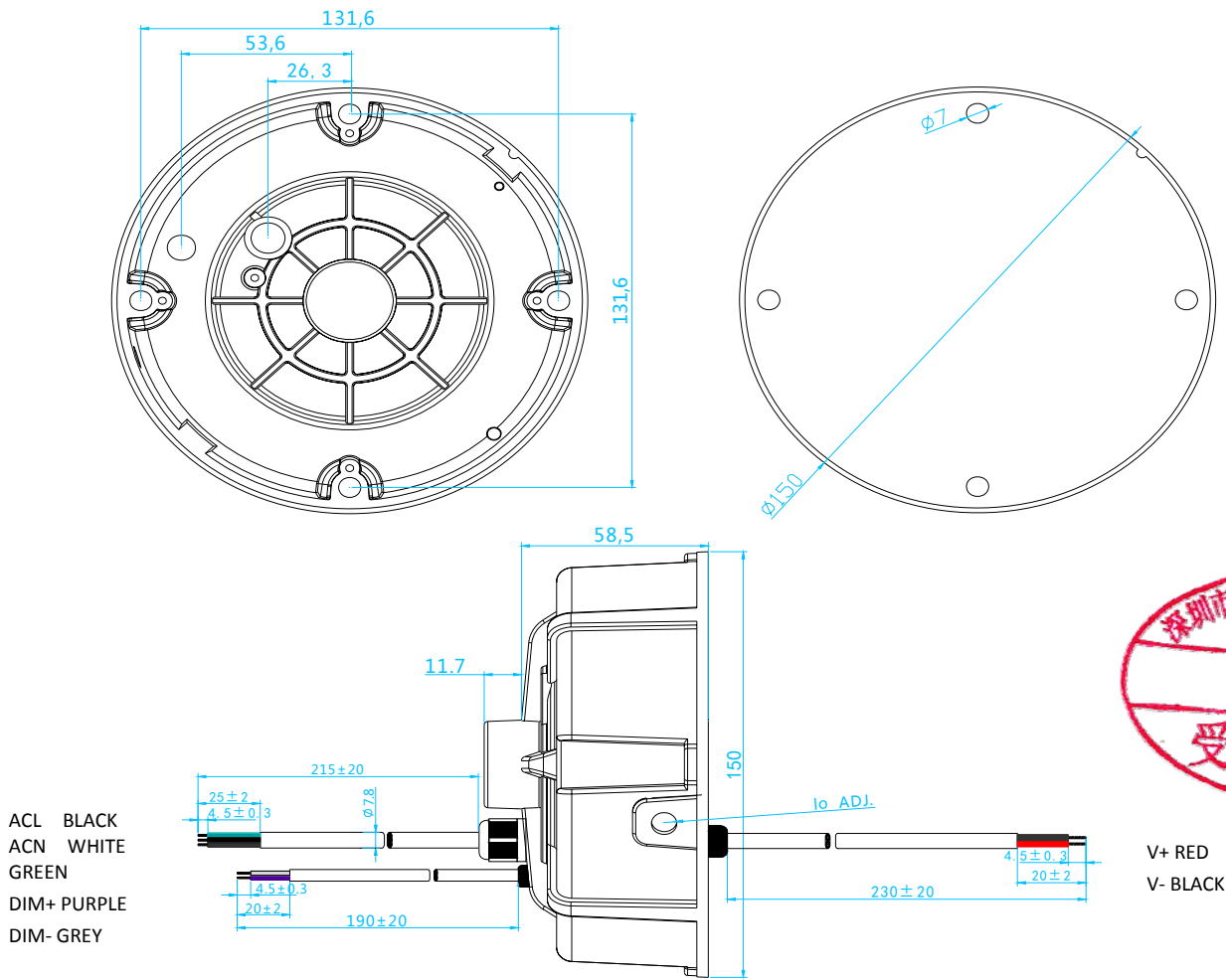

1:AC Power wires: UL STW18# 3x0.824MM(OD8.8MM) Black PVC Skin; Triaxial cables with Black, White, Green. Black: L, White: N, Green: GND

1:AC 电源线: UL STW18# 3x0.824MM(OD8.8MM)黑色 PVC 外皮, 黑白绿三芯线, 黑 L, 白 N, 绿 GND

2:DC power wires: UL SJTW18# 2x0.824MM(OD7.2MM) Black PVC Skin; Two cables with black and red, Red LED+, Black LED-.

2:DC 电源线: UL SJTW18# 2x0.824MM(OD7.2MM)黑色 PVC 外皮, 红黑两芯线, 红 LED+, 黑 LED-

3:Dimming Wires: UL2464(OD6.5MM) 20# Black PVC Skin, Two cables with Purple and Grey, Purple DIM+, Grey DIM-.

3:调光线:UL2464(OD6.5MM)20#黑色 PVC 外皮, 紫灰两芯线, 紫 DIM+, 灰 DIM-

### LABEL 标签示例

**Fahold**  
www.fahold.com

**Constant Current LED Driver**  
**Model: FD-150G-040B**

INPUT: 200-480V~ 0.8A 50/60Hz  
OUTPUT: 24V-40V = 2.5-4.7A Max.150W  
Suitable for use in Dry, Damp and Wet Locations

tc: 85°C  
•tc

RoHS SELV 110 F

UL E479229 FC CE IP67 MADE IN CHINA

**INPUT**

- ACL BLACK
- ACN WHITE
- GREEN

**OUTPUT**

- V+ RED
- V- BLACK
- DIM+ PURPLE
- DIM- GREY
- Io ADJ.

**Fahold**  
www.fahold.com

**Constant Current LED Driver**  
**Model: FD-150G-050B**

INPUT: 200-480V~ 0.8A 50/60Hz  
OUTPUT: 30V-50V = 2.3-4.2A Max.150W  
Suitable for use in Dry, Damp and Wet Locations

tc: 85°C  
•tc

RoHS SELV 110 F

UL E479229 FC CE IP67 MADE IN CHINA

**INPUT**

- ACL BLACK
- ACN WHITE
- GREEN

**OUTPUT**

- V+ RED
- V- BLACK
- DIM+ PURPLE
- DIM- GREY
- Io ADJ.

**Fahold**  
www.fahold.com

**Constant Current LED Driver**  
**Model: FD-150G-060B**

INPUT: 200-480V~ 0.8A 50/60Hz  
OUTPUT: 40V-60V = 2.3-3.6A Max.150W  
Suitable for use in Dry, Damp and Wet Locations

tc: 85°C  
•tc

RoHS SELV 110 F

UL E479229 FC CE IP67 MADE IN CHINA

**INPUT**

- ACL BLACK
- ACN WHITE
- GREEN

**OUTPUT**

- V+ RED
- V- BLACK
- DIM+ PURPLE
- DIM- GREY
- Io ADJ.

**Fahold**  
www.fahold.com

**Constant Current LED Driver**  
**Model: FD-150G-082B**

INPUT: 200-480V~ 0.8A 50/60Hz  
OUTPUT: 50V-82V = 1.3-2.6A Max.150W  
Suitable for use in Dry, Damp and Wet Locations

tc: 85°C  
•tc

RoHS SELV 110 F

UL E479229 FC CE IP67 MADE IN CHINA

**INPUT**

- ACL BLACK
- ACN WHITE
- GREEN

**OUTPUT**

- V+ RED
- V- BLACK
- DIM+ PURPLE
- DIM- GREY
- Io ADJ.

**Fahold**  
www.fahold.com

**Constant Current LED Driver**  
**Model: FD-150G-143B**

INPUT: 200-480V~ 0.8A 50/60Hz  
OUTPUT: 76V-143V = 0.7-1.3A Max.150W  
Suitable for use in Dry, Damp and Wet Locations

tc: 85°C  
•tc

RoHS SELV 110 F

UL E479229 FC CE IP67 MADE IN CHINA

**INPUT**

- ACL BLACK
- ACN WHITE
- GREEN

**OUTPUT**

- V+ RED
- V- BLACK
- DIM+ PURPLE
- DIM- GREY
- Io ADJ.



### 安装注意事项 Installation considerations

1. 若产品有外部可调电位器，请在调整好电流之后，建议用 704 硅胶将调整电流的孔密封好，将防水胶塞盖好。

If the power supply has adjustable external potentiometer, after adjust output current, suggest using 704 silicone sealing good the hole and plug waterproof rubber.

2. 电源的防雷等级满足 IEC61000-4-5 等各国的标准要求，如果使用在雷电多发地区或电网环境相对复杂的地区，建议在电源的 AC 输入端加装专业的防雷模块。

Lightning protection level to meeting IEC61000-4-5 standard requirement, if you use the lightning occurs or the area of power grid environment is relatively complex, suggest in the power supply of the AC input terminal equipped with professional lightning protection module.

### 包装, 运输, 贮存 Package, Transportation & Storage

#### 1. 包装 Package

- a. 包装箱的外形尺寸为 (单位: mm): 长 X 宽 X 高=420X265X190;  
package box outside dimension: L×W×H =420×265×190(unit: mm);
- b. 每箱产品的包装数量为 12 台;  
product number in each box: 12PCS;
- c. 整箱毛重 KG  
whole box gross weight: kg;



#### 2. 运输 Transportation

适用于车, 船, 飞机运输, 运输中应遮蓬, 防晒, 文明装卸。

Packaging is designed suitable for transportation by truck, ship, and plane. The products should be shielded from sunshine, and loaded and unloaded carefully.

#### 3. 贮存 Storage

产品贮存应符合 GB3873-83 的规定。

贮存期限超过一年的产品要重新检验, 合格后方可使用。

The product storage meet the standard of the GB 3873-83.

Product should be rechecked over 1 year.