

TOP LED:Z509FRGBWD (5mm Through-hole LED-RGB)

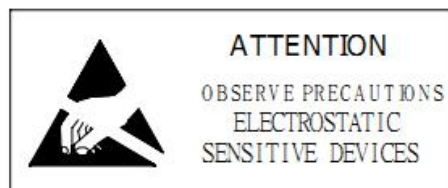

CUSTOMER APPROVED SIGNATURES	SALES APPROVED	APPROVED BY	CHECKED BY	PREPARED BY

1. Features

- Color :Red+Green+Blue LED
- Lens: White diffused
- High Luminous LEDS
- Low forward voltage
- Meet ROHS, Green Product
- Compatible With Infrared Reflow Solder And Wave Solder Process

2. Package Profile & Soldering PAD Suggested

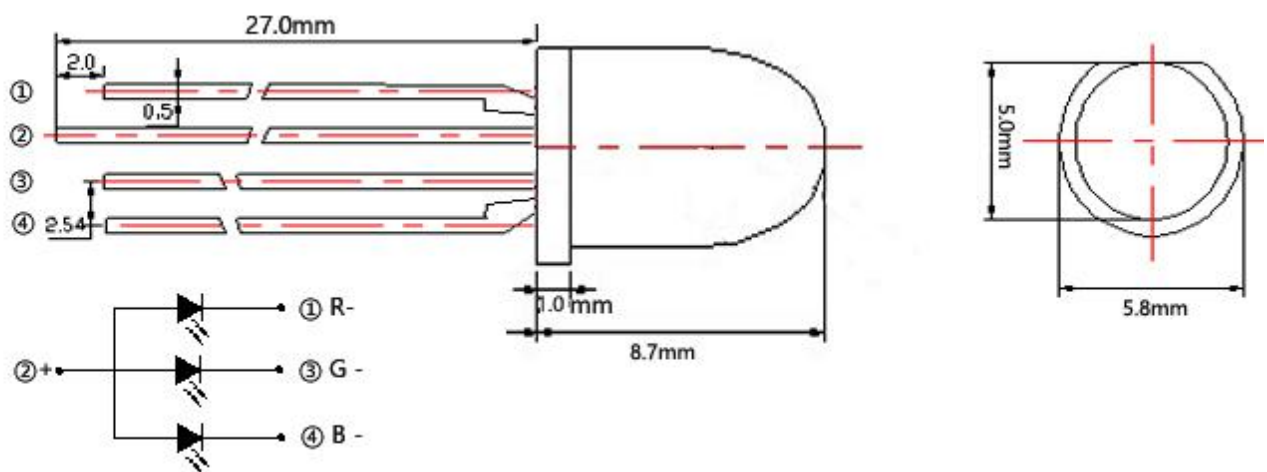

- Notes:
1. All dimensions are in millimeters ;
 2. Tolerance is ± 0.10 mm unless otherwise noted.
 3. RGB common anode.



3. Absolute Maximum Ratings At Ta=25°C

Parameter	Symbol	Rating			Unit
		Red	Green	Blue	
Power Dissipation	Pd	60	100	100	mW
Pulse Forward Current	IFP	100	100	100	mA
Forward Current	IF	30	30	30	mA
Reverse Voltage	VR	5			V
Junction Temperature	Tj	100			°C
Operating Temperature	Topr	-40 ~ +80			°C
Storage Temperature Range	Tstg	-40 ~ +100			°C
Soldering Temperature	Tsol	260			°C
Electro-Static-Discharge(HBM)	ESD	1000			V
Warranty	Time	5			Years
Antistatic bag	Piece	1000			Back

*Pulse Forward Current Condition:Duty 1% and Pulse Width=10us.

*Soldering Condition:Soldering condition must be completed with 3 seconds at 260°C

4. Electrical Optical Characteristics At Ta=25°C

Parameter		Symbol	Min	Typ	Max	Unit	Test Condition
Forward Voltage	Red	VF	1.9	2.0	2.4	V	IF=20mA
	Green		2.8	3.0	3.4		
	Blue		2.8	3.0	3.4		
Luminous Intensity	Red	IV	2000		3500	mcd	IF=20mA
	Green		3500		5500		
	Blue		1500		2500		
Peak Wavelength	Red	λP		633		nm	IF=20mA
	Green			525			
	Blue			460			
Dominant Wavelength	Red	λD	620		630	nm	IF=20mA
	Green		518		525		
	Blue		460		470		
Half Width		$\Delta\lambda$		15		nm	IF=20mA
Viewing Half Angle		$2\theta_{1/2}$		± 20		deg	IF=20mA
Reverse Current		IR			5	μA	VR=5V
Rise Time		tr		10		ns	IF=20mA
Fall Time		tf		10		ns	IF=20mA

*Luminous Intensity is measured by ZWL600.

* $\theta_{1/2}$ is the off-axis angle at which the luminous intensity is half the axial luminous intensity.

* λP is derived from the CIE chromaticity diagram and represents the single wavelength which defines the color of the device.

5. Typical Electrical-Optical Characteristics Curves (Red+Green+Blue)

Red:

Relative Intensity Vs. Wavelength (Ta=25°C)

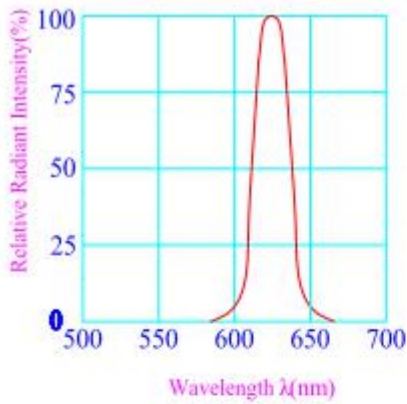

Forward Current Vs. Ambient Temperature

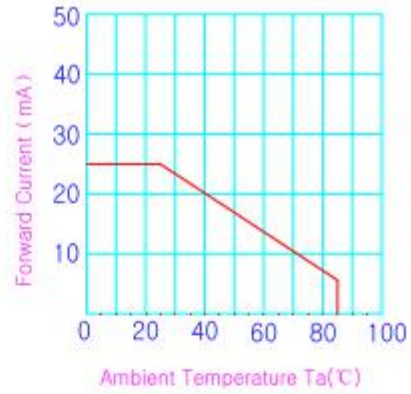

Forward Current Vs. Forward Voltage



Forward Voltage Vs. Ambient Temperature

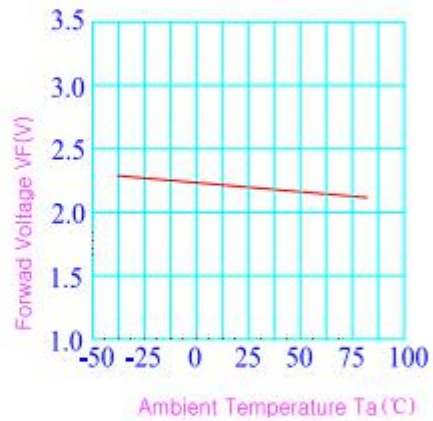

Luminous Intensity Vs. Forward Current

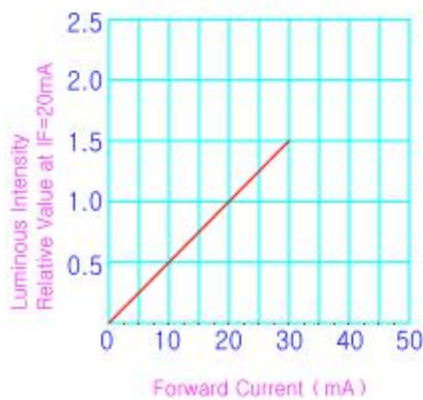

Luminous Intensity Vs. Ambient Temperature

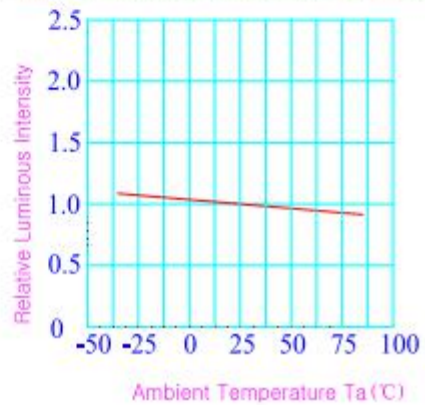

Green:

Relative Intensity Vs. Wavelength (Ta=25°C)

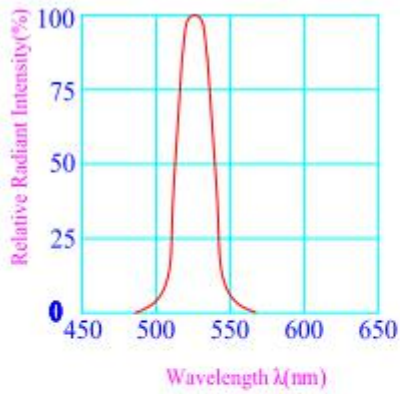

Forward Current Vs. Ambient Temperature

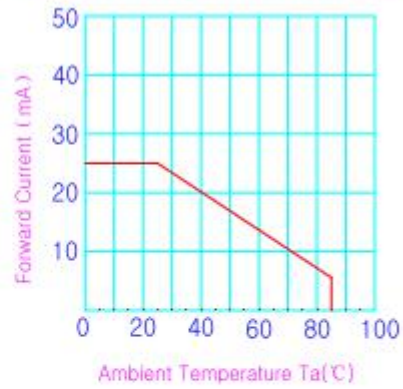

Forward Current Vs. Forward Voltage

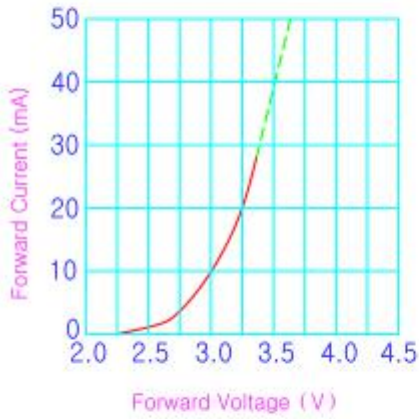

Forward Voltage Vs. Ambient Temperature

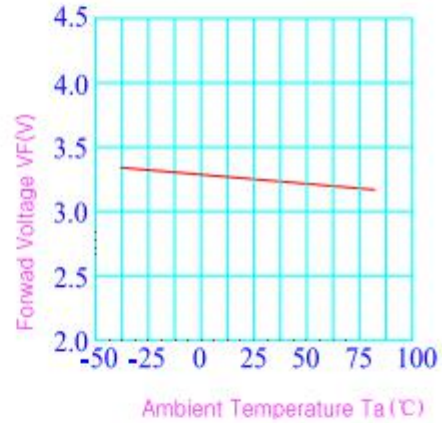

Luminous Intensity Vs. Forward Current

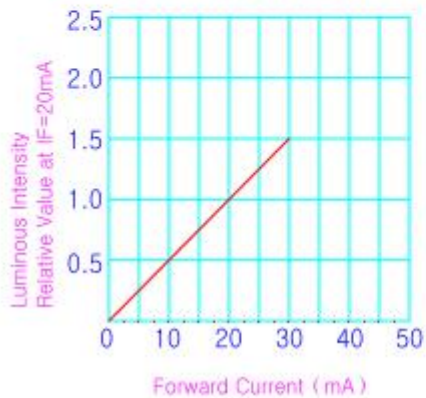

Luminous Intensity Vs. Ambient Temperature

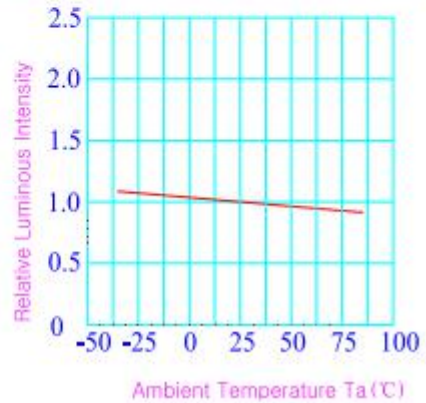

Blue:

Relative Intensity Vs. Wavelength (Ta=25°C)

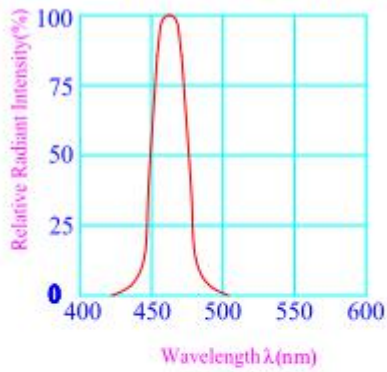

Forward Current Vs. Ambient Temperature

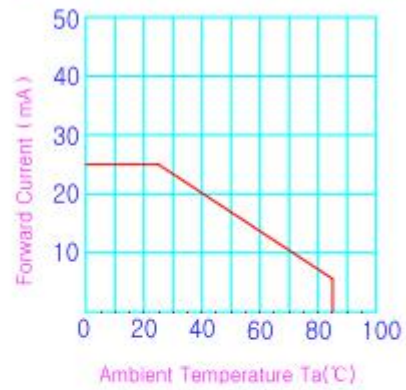

Forward Current Vs. Forward Voltage

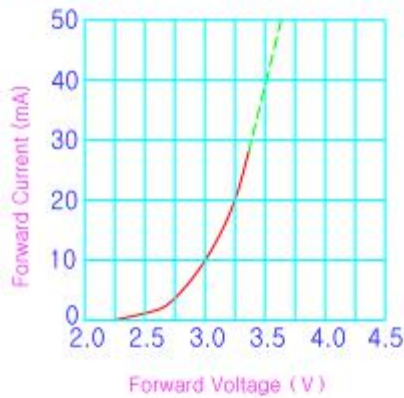

Forward Voltage Vs. Ambient Temperature

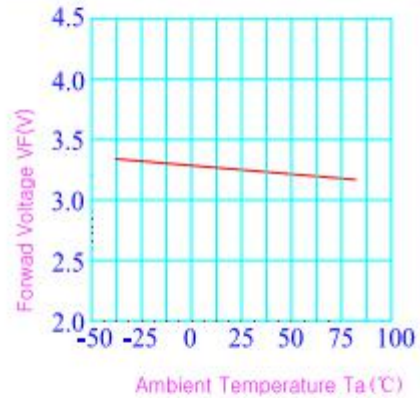

Luminous Intensity Vs. Forward Current

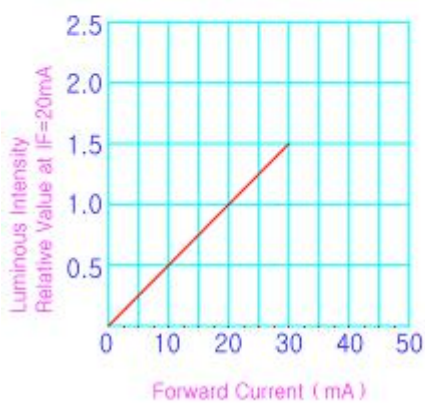

Luminous Intensity Vs. Ambient Temperature

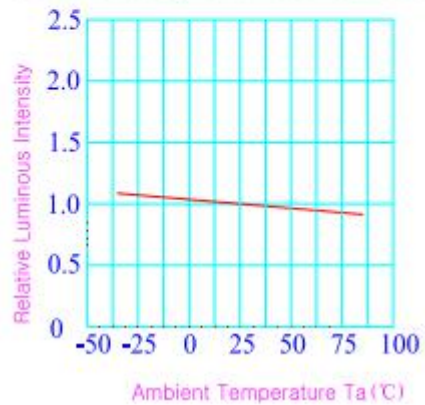



3. Use anti-static package or boxes to carry and storage LEDs. And ordinary plastic package or boxes is forbidden to use.
4. Use ionizer to neutralize the static charge during handling or operating.
5. All surfaces and objects within 1 ft close to LEDs measure less than 100V.

Cleaning

Use alcohol-based cleaning solvents such as IPA (isopropyl alcohol) to clean LEDs if necessary.

Soldering

1. Soldering condition refer to the draft "Soldering Profile Suggested" on page 1.
2. Reflow soldering should not be done more than 2 times.
3. Manual soldering is only suggested on repair and rework. The maximum soldering temperature should not exceed 300°C within 3 sec. And the maximum capacity of soldering iron is 30W in power.
4. During the soldering process, do not touch the lens at high temperature.
5. After soldering, any mechanical force on the lens or any excessive vibration shall not be accepted to apply, also the circuit board shall not be bent as well.

Others

1. The LEDs described here are intended to be used for ordinary electronic equipment (such as office equipment, communication equipment and household applications).Consult BESTSMD's Sales in advance for the applications in which exceptional reliability is required, particularly when the failure or malfunction of the LEDs may directly jeopardize life or health. (such as in aviation, transportation, traffic control equipment, medical and life support systems and safety devices).
2. The light output from the high luminous intensity LEDs may cause injury to human eyes when viewed directly.
3. The appearance and specifications of the product may be modified for improvement without prior notice.