



SHENZHEN BEST LED OPTO-ELECTRONIC CO.,LTD

TOP LED:3528IRC-94L14I80 (3528SMD LED - 940nm IR)



	ATTENTION OBSERVE PRECAUTIONS ELECTROSTATIC SENSITIVE DEVICES
--	---



CUSTOMER APPROVED SIGNATURES	SALES APPROVED	APPROVED BY	CHECKED BY	PREPARED BY

1. Features

- Color :940nm IR LED
- Lens: Water clear
- Chip Size:3500um*350um
- AlGaAs/AlGaAs infrared chip
- EIA STD Package
- Meet ROHS, Green Product
- Compatible With SMT Automatic Equipment
- Compatible With Infrared Reflow Solder And Wave Solder Process

2. Package Profile & Soldering PAD Suggested

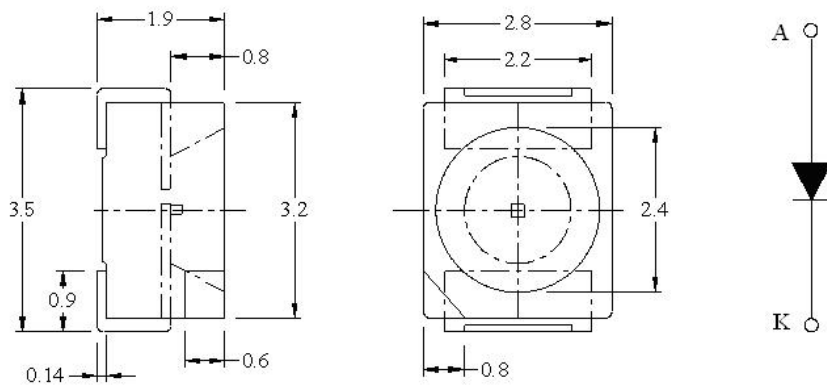

- Notes: 1. All dimensions are in millimeters ;
2.Tolerance is ± 0.10 mm unless otherwise noted.



3. Absolute Maximum Ratings At Ta=25°C

Parameter	Symbol	Rating	Unit
Power Dissipation	Pd	200	mW
Peak Forward Current (1/10 Duty Cycle, 0.1ms Pulse Width)	IFP	300	mA
DC Forward Current	IF	100	mA
Reverse Voltage	VR	5	V
Operating Temperature Range	Topr	-25°C ~ +80°C	
Storage Temperature Range	Tstg	-40°C ~ +80°C	
Soldering Condition	Tsol	Reflow soldering : 250°C For 5 Seconds Hand soldering: 300°C For 3 Seconds	
Electro-Static-Discharge(HBM)	ESD	2000V	
Service life under normal conditions	Time	80000h	
Service life under normal conditions	Time	2 years	
Packing	pcs	2000per reel	

4. Electrical Optical Characteristics At Ta=25°C

Parameter	Symbol	Min.	Typ.	Max.	Unit	Condition
Radiant Intensity	Ee	4		8	mW/sr	IF=20mA
		12		20		IF=50mA
		20		30		IF=100mA
Viewing Angle	2θ1/2		120		deg	IF=20mA
Peak Wavelength	λp	930	940	950	nm	IF=20mA
Spectral Bandwidth	Δλ		45		nm	IF=20mA
Forward Voltage	VF	1.1	1.2	1.4	V	IF=20mA
		1.2	1.3	1.5		IF=50mA
			1.8			IF=100mA
Reverse Current	IR			5	uA	VR=5V

Notes: 1. Luminous intensity is measured with a light sensor and filter combination that approximates the CIE eye-response curve.

2. θ1/2 is the off-axis angle at which the luminous intensity is half the axial luminous intensity.

3. The dominant wavelength, λd is derived from the CIE chromaticity diagram and represents the single wavelength which defines the color of the device.

5. Typical Electrical-Optical Characteristics Curves

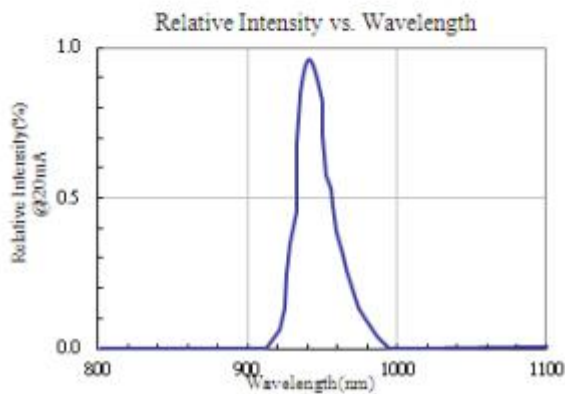
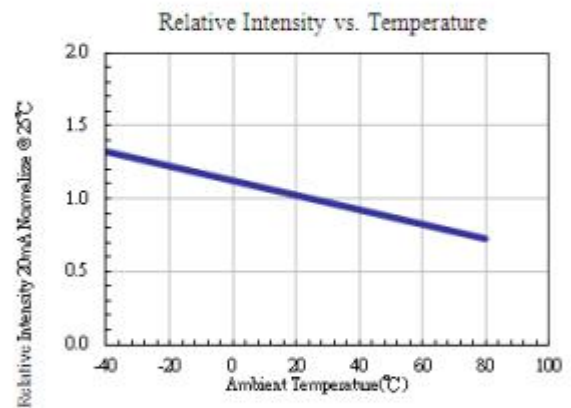
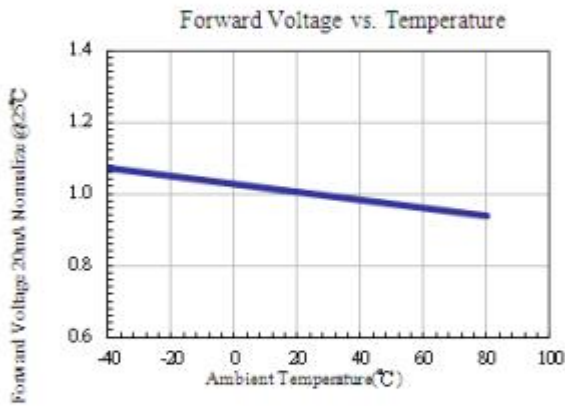
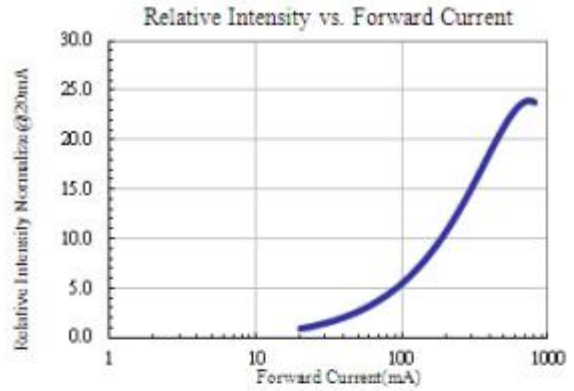
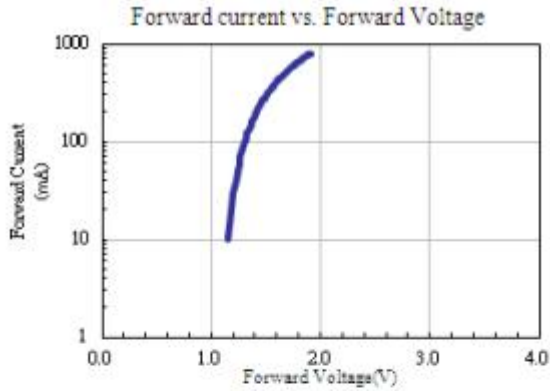

6. SMD LED Technical Data

Reflow soldering profile for LEAD-FREE SMD process

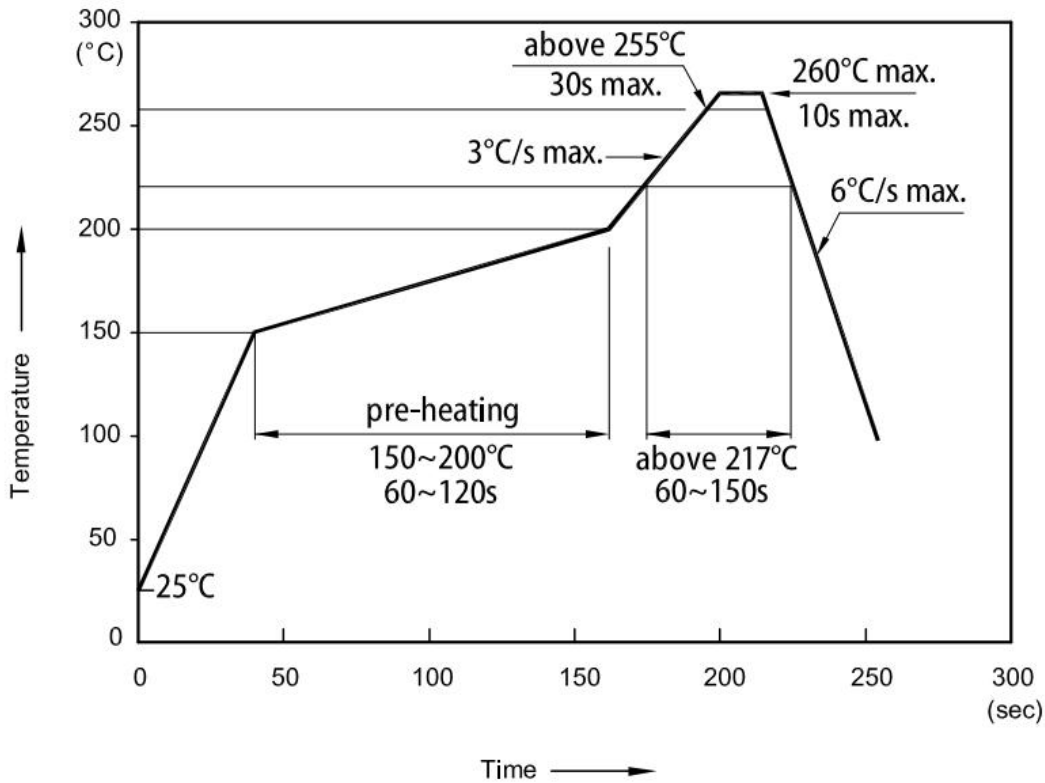

Notes:

1. Don't cause stress to the LEDs while it is exposed to high temperature.
2. The maximum number of reflow soldering passes is 2 times
3. Reflow soldering is recommended. Other soldering methods are not recommended as they might cause damage to the product

HANDLING PRECAUTIONS

Compare to epoxy encapsulant that is hard and brittle, silicone is softer and flexible. Although its characteristic significantly reduces thermal stress, it is more susceptible to damage by external mechanical force. As a result, special handling precautions need to be observed during assembly using silicone encapsulated LED products. Failure to comply might lead to damage and premature failure of the LED.

1. Handle the component along the side surfaces by using forceps or appropriate tools.



2. Do not directly touch or handle the silicone lens surface. It may damage the internal circuitry.

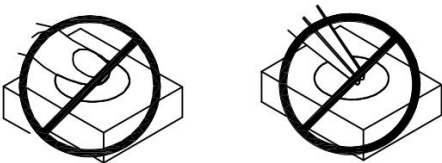

3. Do not stack together assembled PCBs containing exposed LEDs. Impact may scratch the silicone lens or damage the internal circuitry.



4. 4-A The inner diameter of the SMD pickup nozzle should not exceed the size of the LED to prevent air leaks

4-B A pliable material is suggested for the nozzle tip to avoid scratching or damaging the LED surface during pickup

4-C The dimensions of the component must be accurately programmed in the pick-and-place machine to insure precise pickup and avoid damage during production

4-D As silicone encapsulation is permeable to gases, some corrosive substances such as H₂S might corrode silver plating of leadframe. Special care should be taken if an LED with Silicone encapsulation is to be used near such substances.

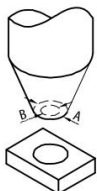

5. Avoid continued exposure to the condensing moisture environment and keep the product away from rapid transitions in ambient temperature.

6. Product in the original sealed package is recommended to be assembled within 12 hours of opening.

7. If there is damp phenomenon, please return to the original factory in time and use it again after 150 degrees high temperature treatment.