

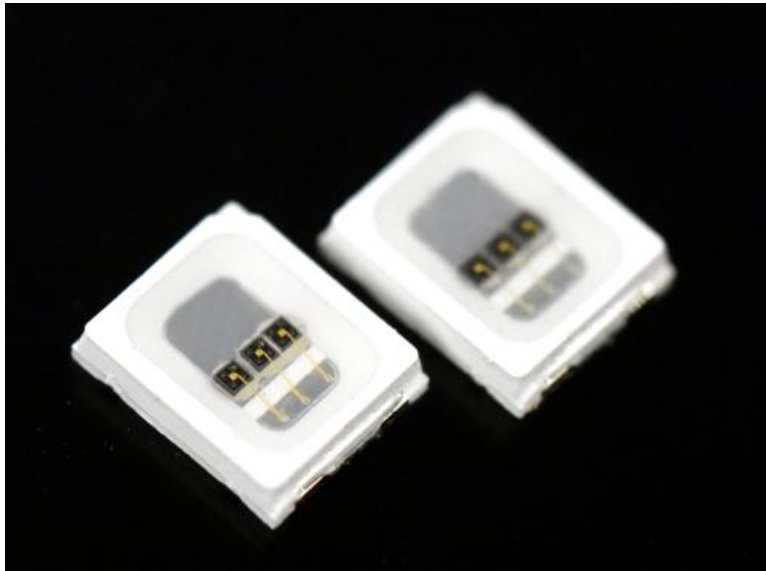

TOP LED:2835FIRC-88ES14I300-3P (2835SMD LED-3chips IR LED)



	ATTENTION OBSERVE PRECAUTIONS ELECTROSTATIC SENSITIVE DEVICES
---	---



CUSTOMER APPROVED SIGNATURES	SALES APPROVED	APPROVED BY	CHECKED BY	PREPARED BY

1. Features

- Color :880nm IR LED
- Lens: Water clear
- High reliability,High radiant intensity
- Low forward voltage
- Meet ROHS, Green Product
- Compatible With Infrared Reflow Solder And Wave Solder Process

2. Package Profile & Soldering PAD Suggested

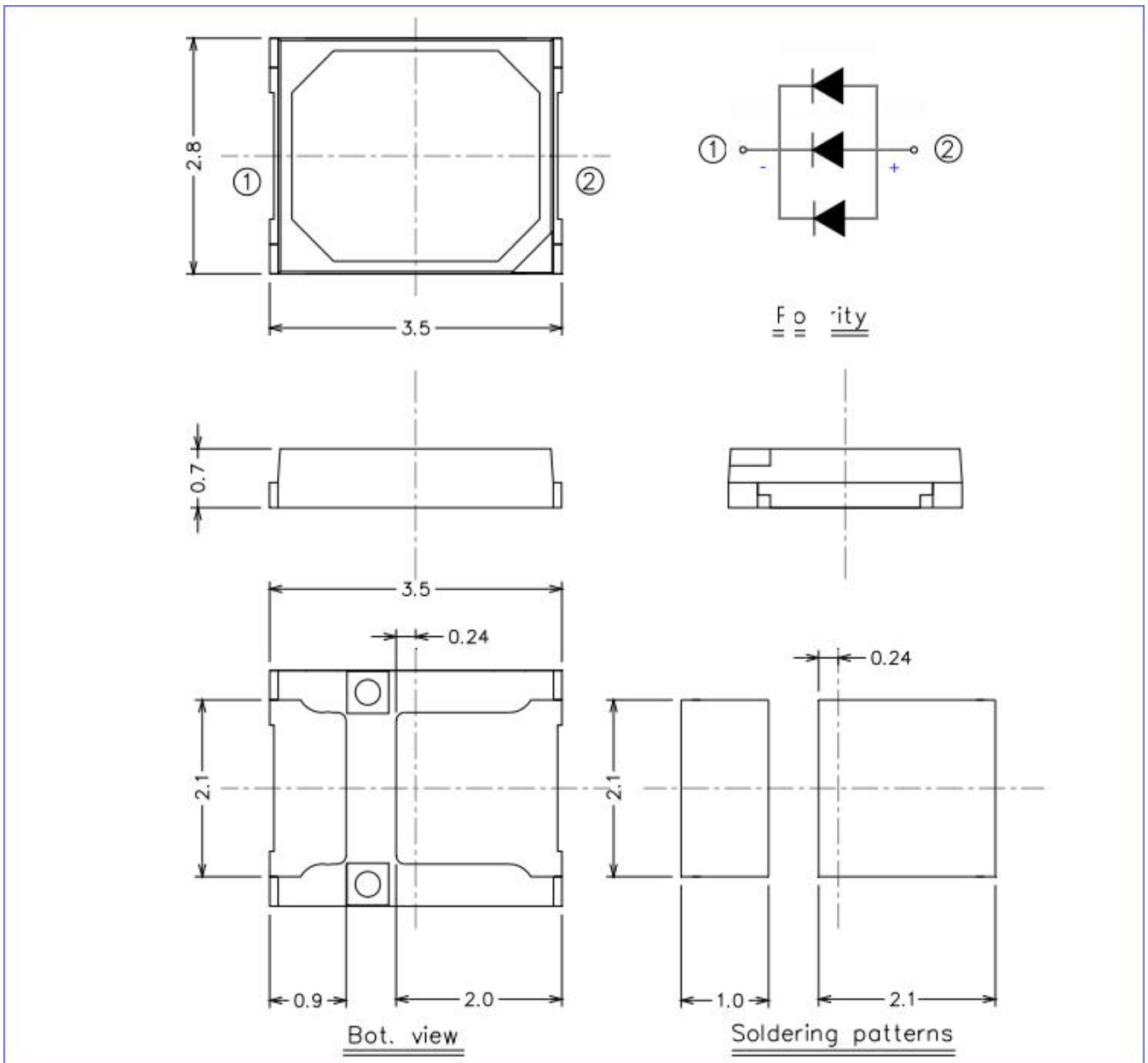

Notes: 1. All dimensions are in millimeters ;

2. Tolerance is ± 0.10 mm unless otherwise noted.



3. Absolute Maximum Ratings At Ta=25°C

Parameter	Symbol	Rating	Unit
Power Dissipation	Pd	600	mW
Pulse Forward Current	IFP	1500	mA
Forward Current	IF	300	mA
Reverse Voltage	VR	5	V
Junction Temperature	Tj	115	°C
Operating Temperature	Topr	-40 ~ +80	°C
Storage Temperature Range	Tstg	-40 ~ +100	°C
Soldering Temperature	Tsol	260	°C
Electro-Static-Discharge(HBM)	ESD	1000	V
Service life under normal conditions	Time	80000	H
Warranty	Time	5	Years
Antistatic bag	Piece	4000	Bag

*Pulse Forward Current Condition:Duty 1% and Pulse Width=10us.

*Soldering Condition:Soldering condition must be completed with 3 seconds at 260°C

4. Electrical Optical Characteristics At Ta=25°C

Parameter	Symbol	Min	Typ	Max	Unit	Test Condition
Radiant Intensity	Ee	20		30	mW/sr	IF=60mA
		50	70			IF=150mA
		90		120		IF=300mA
Viewing Angle	2θ1/2		120		deg	IF=150mA
Peak Wavelength	λp	880	895	910	nm	IF=150mA
Spectral Bandwidth	Δλ		50		nm	IF=150mA
Forward Voltage	VF	1.2	1.3	1.6	V	IF=60mA
		1.3	1.5	1.7		IF=150mA
		1.6	1.8	2.0		IF=300mA
Reverse Current	IR			5	uA	VR=5V

*Luminous Intensity is measured by ZWL600.

*θ1/2 is the off-axis angle at which the luminous intensity is half the axial luminous intensity.

*λP is derived from the CIE chromaticity diagram and represents the single wavelength which defines the color of the device.

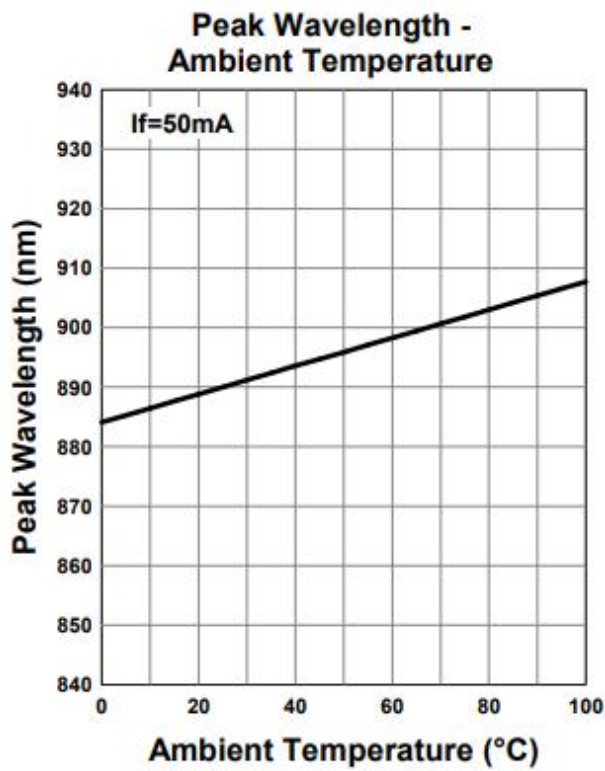
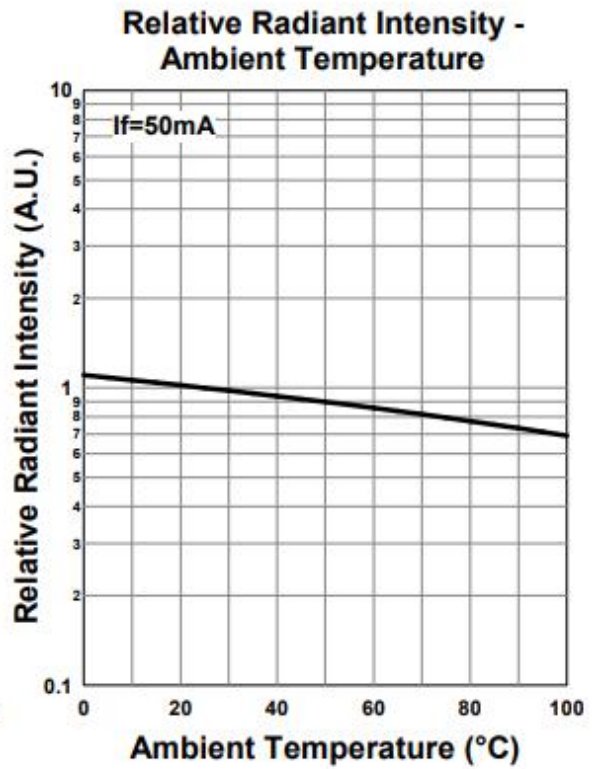
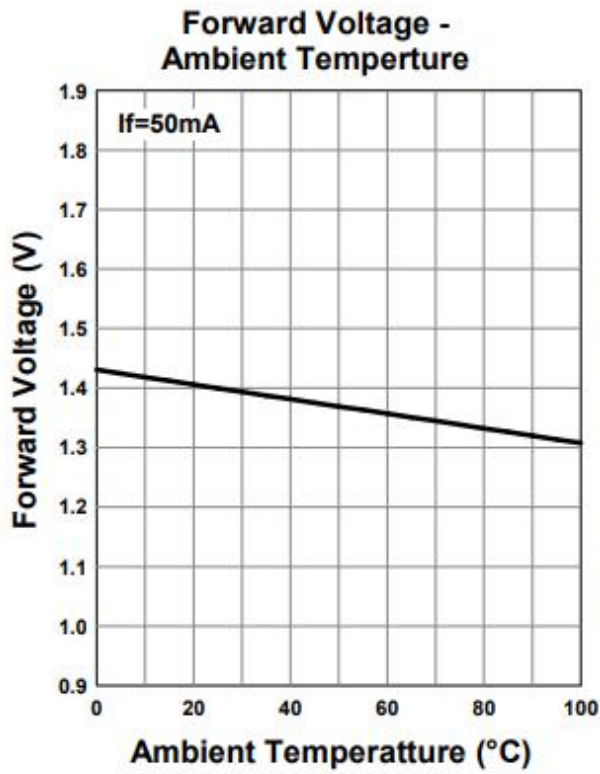

Relative Spectral Emission

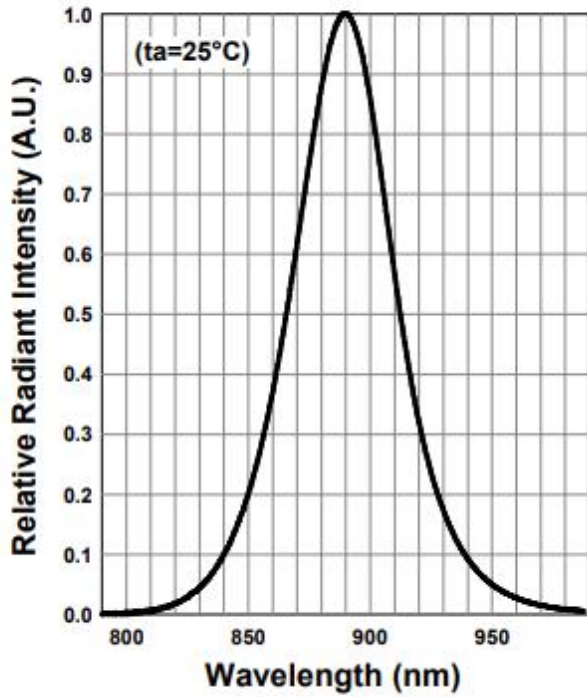

Radiation Characteristics

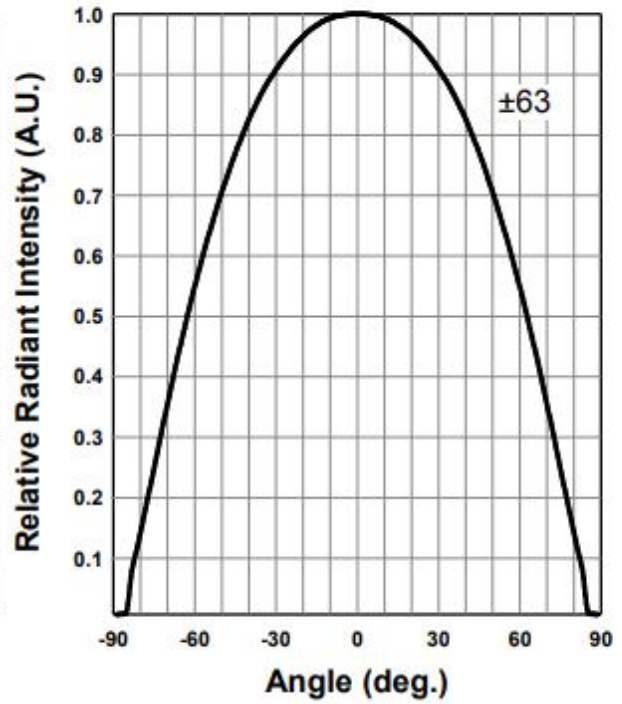

Radiation Characteristics

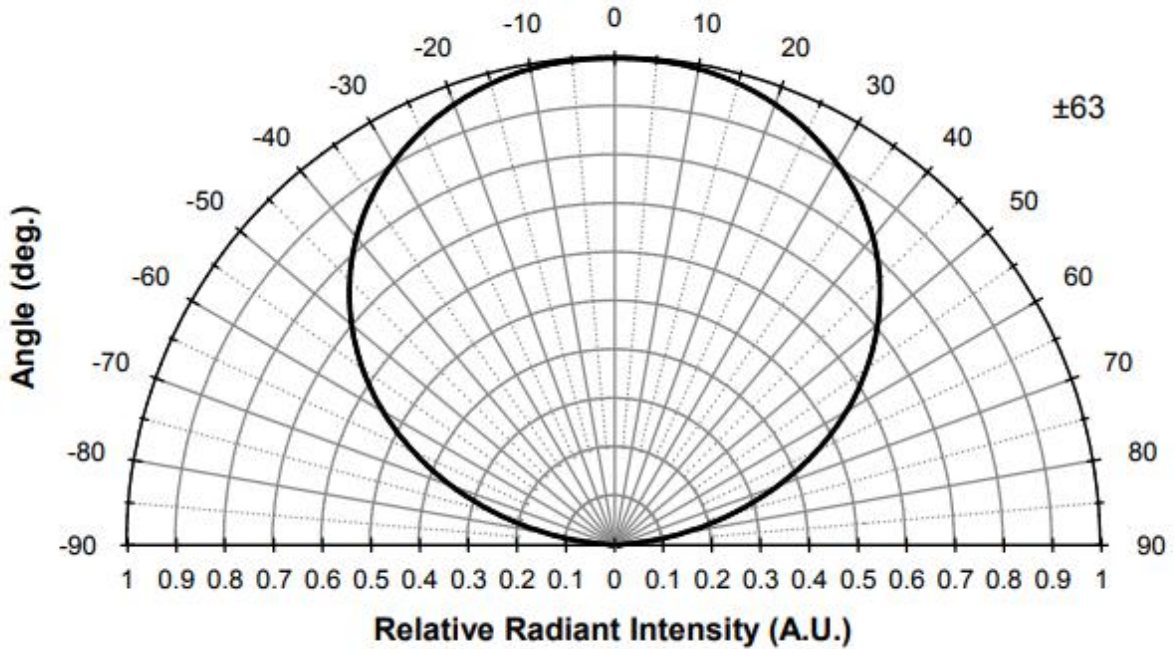

6. Cautions

Reflow soldering profile for LEAD-FREE SMD process

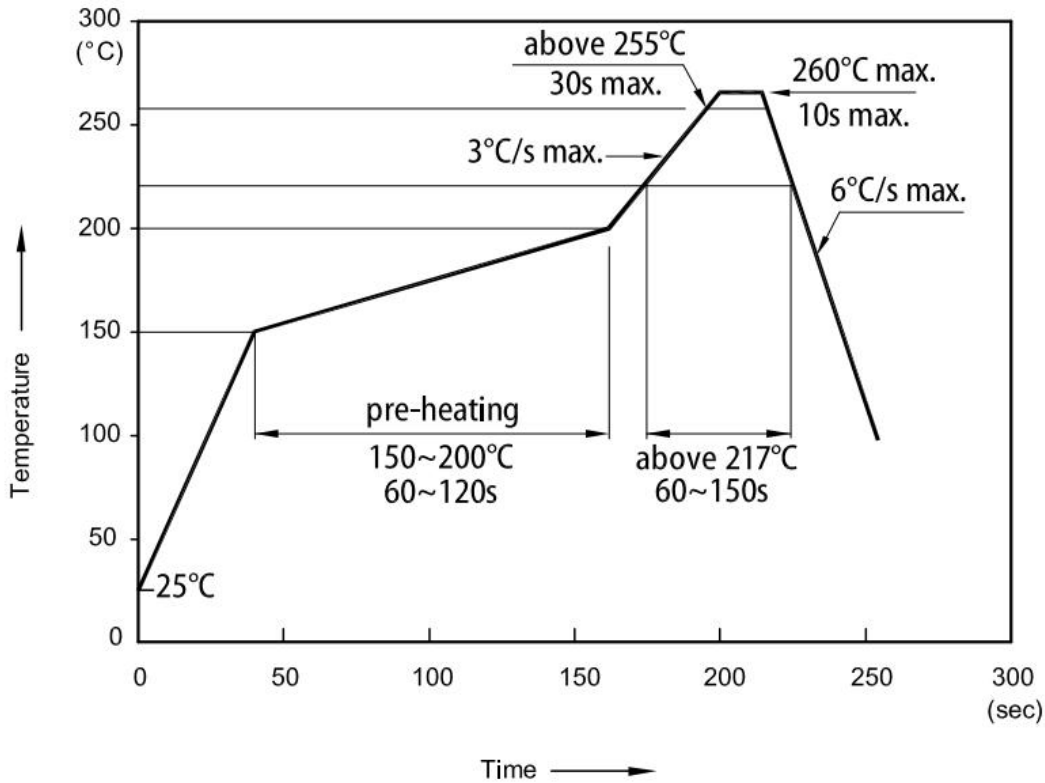

Notes:

1. Don't cause stress to the LEDs while it is exposed to high temperature.
2. The maximum number of reflow soldering passes is 2 times
3. Reflow soldering is recommended. Other soldering methods are not recommended as they might cause damage to the product

HANDLING PRECAUTIONS

Compare to epoxy encapsulant that is hard and brittle, silicone is softer and flexible. Although its characteristic significantly reduces thermal stress, it is more susceptible to damage by external mechanical force. As a result, special handling precautions need to be observed during assembly using silicone encapsulated LED products. Failure to comply might lead to damage and premature failure of the LED.

1. Handle the component along the side surfaces by using forceps or appropriate tools.



2. Do not directly touch or handle the silicone lens surface. It may damage the internal circuitry.

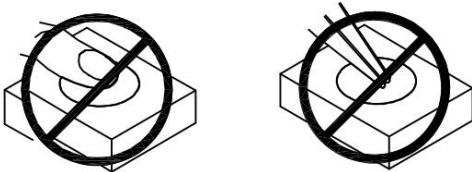

3. Do not stack together assembled PCBs containing exposed LEDs. Impact may scratch the silicone lens or damage the internal circuitry.



4. 4-A The inner diameter of the SMD pickup nozzle should not exceed the size of the LED to prevent air leaks

4-B A pliable material is suggested for the nozzle tip to avoid scratching or damaging the LED surface during pickup

4-C The dimensions of the component must be accurately programmed in the pick-and-place machine to insure precise pickup and avoid damage during production

4-D As silicone encapsulation is permeable to gases, some corrosive substances such as H₂S might corrode silver plating of leadframe. Special care should be taken if an LED with Silicone encapsulation is to be used near such substances.

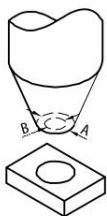

5. Avoid continued exposure to the condensing moisture environment and keep the product away from rapid transitions in ambient temperature.

6. Product in the original sealed package is recommended to be assembled within 24 hours of opening.