



PRODUCT FEATURES

- Universal input voltage: 90~305Vac;
- Constant power design;
- (M types) Offline programming through dimming wire, (V types) Setting current with a built-in variable resistor;
- 2-in-1 dimming mode: 0-10Vdc, PWM dimming; Dim-to-off;
- Surge protection: 4KV line-line, 6KV line-earth;
- Multiple protection: SCP, OVP, OTP;
- IP65 design for indoor and outdoor applications;
- 5 years warranty.



APPLICATION

- Suitable for industrial lighting.

DESCRIPTION

MTP-120 series is specially designed for industrial lighting applications. It is constant power LED driver that operates from 90-305Vac with 0-10V and PWM dimming function. The output parameters are configurable by internal potentiometer or dimming wire within a wide range of DC Load. This round integrated structure enables it to have a better heat dissipation cooler, significantly improving reliability and extending product life. To ensure trouble free operation, protection is provided against input surge, output over voltage, short circuit, and over temperature.

MODELS

Model Number	Max Output Power (W)	Output Voltage Range (Vdc)	Output Current Adjustable Range (A)	Full Power Current Adjustable Range (A)	Default Output Setting	Typical Efficiency [2]	Power Factor	
							120Vac	230Vac
MTP-120X040 ^[1]	120	24~40V	2.0~3.75	3.0~3.75	24~32V/3.75A	89%	0.99	0.97
MTP-120X054	120	27~54V	1.5~2.85	2.25~2.85	27~42V/2.85A	90%	0.99	0.97
MTP-120X068	120	40~68V	1.2~2.15	1.77~2.15	40~56V/2.15A	91%	0.99	0.97

Notes:

1. X=M, programming through dimming wire; X=V, output current adjustable through potentiometer;
2. All parameters not specially mentioned are measured at 230Vac input, full load and 25 °C of ambient temperature.

OPERATING AREA I-V

MTP-120X040

Output Current Vs Load Voltage Curve

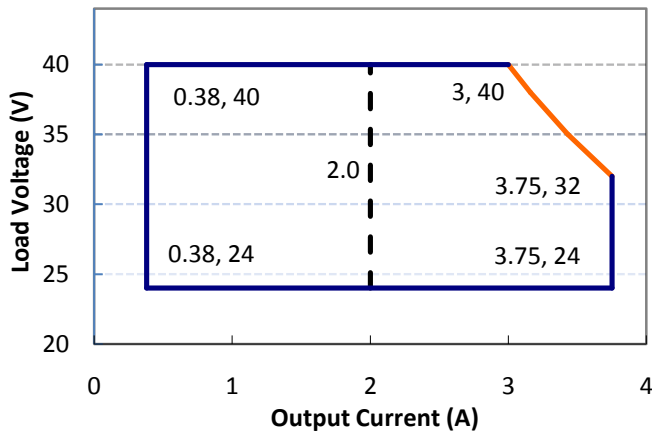

MTP-120X054

Output Current Vs Load Voltage Curve

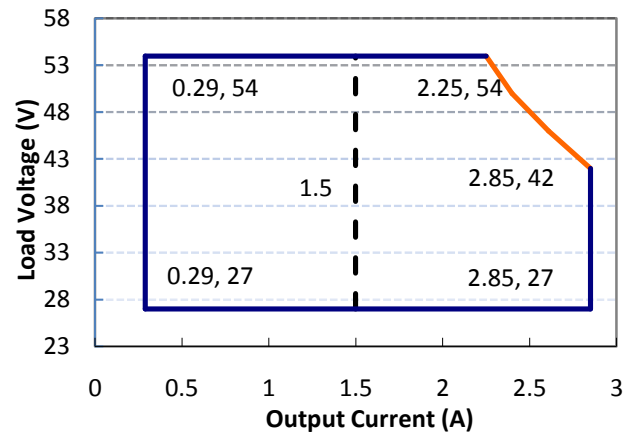

MTP-120X068

Output Current Vs Load Voltage Curve

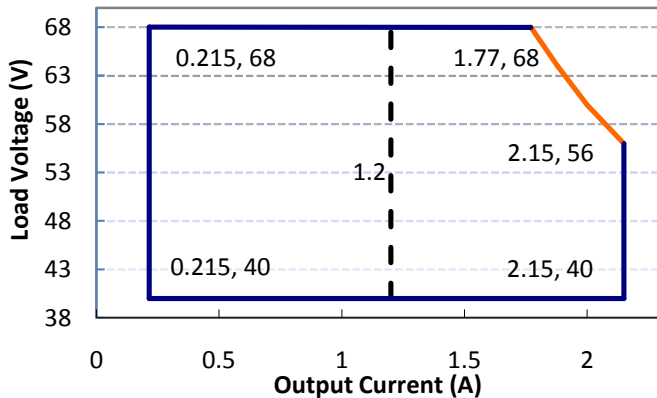

Note: X=V is suitable for the dotted line on the right side area; X=M is suitable for the solid line contain area.

INPUT SPECIFICATIONS

Parameter	Min.	Typ.	Max.	Notes
Input Voltage	90Vac	100-277Vac	305Vac	
Input Frequency	47Hz	50/60	63Hz	
Leakage Current	-	-	0.7mA	277Vac/60Hz
Input AC Current	-	-	1.8A	100-277Vac & full load
Inrush Current	-	-	75A	230Vac, full load
Power Factor	0.95	0.97	-	230Vac, full load
THD	-	6%	10%	120-230Vac, 80%-100% Load
	-	-	20%	277Vac, 70%-100% Load

OUTPUT SPECIFICATIONS

Parameter	Min.	Typ.	Max.	Notes
Output Current Tolerance	-5%	-	5%	
Output Current Setting Range (A)				(M types) Output Current Setting Range: 10%-100%I _{max}
MTP-120X040	2.0	-	3.75	
MTP-120X054	1.5		2.85	
MTP-120X068	1.2		2.15	
Output Current Setting Range with Constant Power(A)				
MTP-120X040	3.00	-	3.75	
MTP-120X054	2.25		2.85	
MTP-120X068	1.77		2.15	
Total Output Current Ripple (pk-pk)	-	5%	10%	20MHz BW, 100% Load & load is LED, ripple is different with difference LED load
Startup Overshoot Current	-	-	10%	120~277Vac & 100% Load, load is LED
No Load Output Voltage(V)				
MTP-120X040	-	-	60	
MTP-120X054			70	
MTP-120X068			80	
Line Regulation	-	-	1%	25°C±10°C ambient temperature, input voltage changes from 115Vac to 277Vac
Load Regulation	-	-	3%	25°C±10°C ambient temperature, 230Vac input, load changes from 60% to 100%.
Turn-on Delay Time	-	-	3S	120Vac, 100%Load
	-	0.5S	1S	230Vac, 100%Load

GENERAL SPECIFICATIONS

Parameter		Min.	Typ.	Max.	Notes
Efficiency @120Vac MTP-120X040 I _o =3.00 I _o =3.75 MTP-120X054 I _o =2.25 I _o =2.85 MTP-120X068 I _o =1.77 I _o =2.15		84% 84%	86% 86%	-	Measured at full load and 25°C ambient temperature, full load.
Efficiency @230Vac MTP-120X040 I _o =3.00 I _o =3.75 MTP-120X054 I _o =2.25 I _o =2.85 MTP-120X068 I _o =1.77 I _o =2.15		87% 87%	89% 89%	-	Measured at full load and 25°C ambient temperature, full load.
Efficiency @277Vac MTP-120X040 I _o =3.00 I _o =3.75 MTP-120X054 I _o =2.25 I _o =2.85 MTP-120X068 I _o =1.77 I _o =2.15		87% 87%	89% 89%	-	Measured at full load and 25°C ambient temperature, full load.
Dielectric Strength	Input-Output	-	3750Vac	-	10mA/60S
	Input-PE	-	1600Vac	-	
	Output- PE	-	1600Vac	-	
Grounding Resistance		-	-	0.1Ω	25A/60S
Insulation Resistance		50MΩ	-	-	Input-Output, Input-PE, Output-PE, 500Vdc/60S/25°C/70%RH
MTBF		-	200000Hrs	-	25°C±10°C ambient temperature, 230Vac, 80% load (MIL-HDBK-217F)
Lifetime		-	50000 Hrs	-	230Vac&100% load, 70°C case temperature, refer to lifetime VS Tc curve for details
Operating Case Temperature for Safety Tc _s		-40°C	-	+90°C	
Operating Case Temperature for Warranty Tc _w		-40°C	-	+70°C	5 years warranty Humidity: 10% to 95% RH
Storage Temperature		-40°C	-	+85°C	Humidity: 5% to 100% RH
Dimensions (DxH)mm		Φ130×74.1			
Net Weight		1000±100g/PCS			
Package		L460*W390*H200mm; 8PCS/Ctn.			

DIMMING

Parameter		Min.	Typ.	Max.	Parameter
0~10V Absolute Maximum Voltage on the Vdim (+) Pin		-	10V	-	
0~10V Source Current on Vdim(+)Pin		-	1mA	2mA	
Dimming Output Range	MTP-120M040 MTP-120M054 MTP-120M068	10% I _{max}	-	100% I _{max}	I _{max} =3.75A I _{max} =2.85A I _{max} =2.15A
	MTP-120M040 MTP-120M054 MTP-120M068	0.38A 0.29A 0.22A	-	3.75A 2.85A 2.15A	
Recommended Dimming Range for 0-10V		0V	-	10V	Default 0-10V/PWM dimming,
PWM_in High Level		9.7V	-	10.3V	
PWM_in Low Level		0V	-	0.3V	
PWM_in Frequency Range		200Hz	-	2KHz	
PWM_in Duty Cycle		10%	-	100%	

SAFTY STANDARDS

Safety Category	Country / Territory	Standards	Whether have Certification
CCC	China	GB19510.1, GB19510.14	√
CE	Europe	EN61347-1, EN61347-2-13	√
		EN62493	√
ENEC		EN62384	√
CB	CB Countries	IEC61347-1, IEC61347-2-13	√
BIS	India	IS 15885(PART 2/SEC 13)	
UL	USA	UL 8750	√
CUL	Canada	CSA C22.2 No.250.13	√
KC	South Korea	K61347-1, K61347-2-13	
PSE	Japan	J61347-1, J61347-2-13	
SAA	Australia	AS/NZS IEC 61347.2.13	√
		AS/NZS 61347.1	√

EMC COMPLIANCE

EMC Category	Country / Territory	Standards	Whether have Certification
CCC	China	GB/T 17743, GB 17625.1	√
CE	Europe	EN 55015	√
		EN 61000-3-2, EN 61000-3-3	√
		EN61000-4-2,3,4,5,6,11	√
		EN 61547	√
KC	South Korea	K61547	
		K00015	
PSE	Japan	J55015	
FCC	USA	FCC part 15	

NOTE:

This LED driver meets the EMI specifications above, but EMI performance of a luminaire that contains it depends also on the other devices connected to the driver and on the fixture itself.

INRUSH CURRENT WAVEFORM

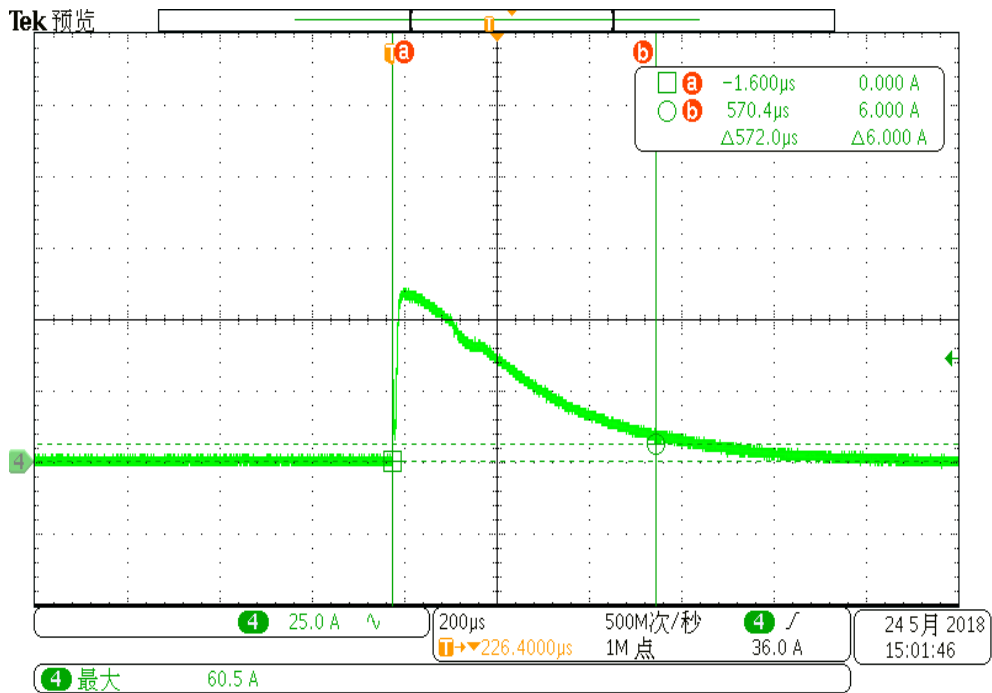

DERATING CURVE

Derating curve

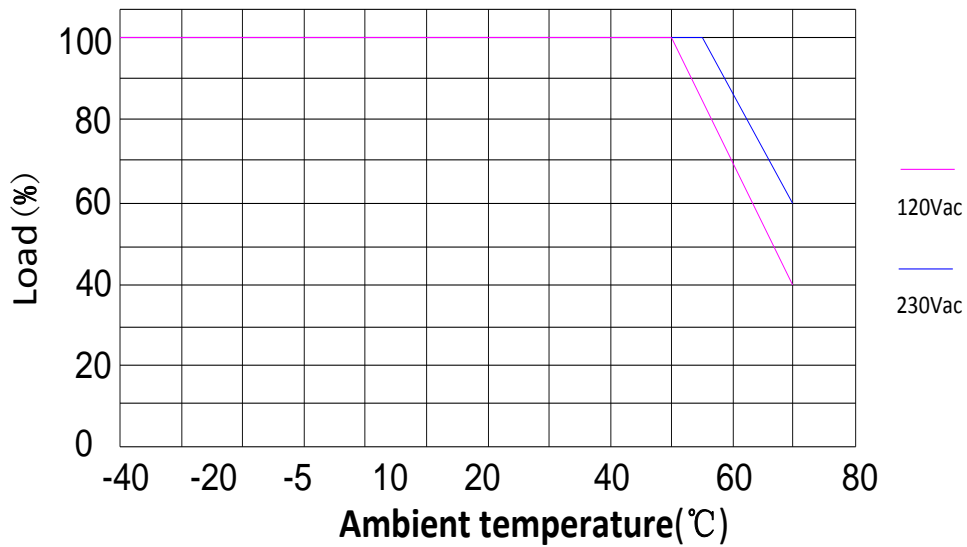

OUTPUT POWER VS INPUT VOLTAGE

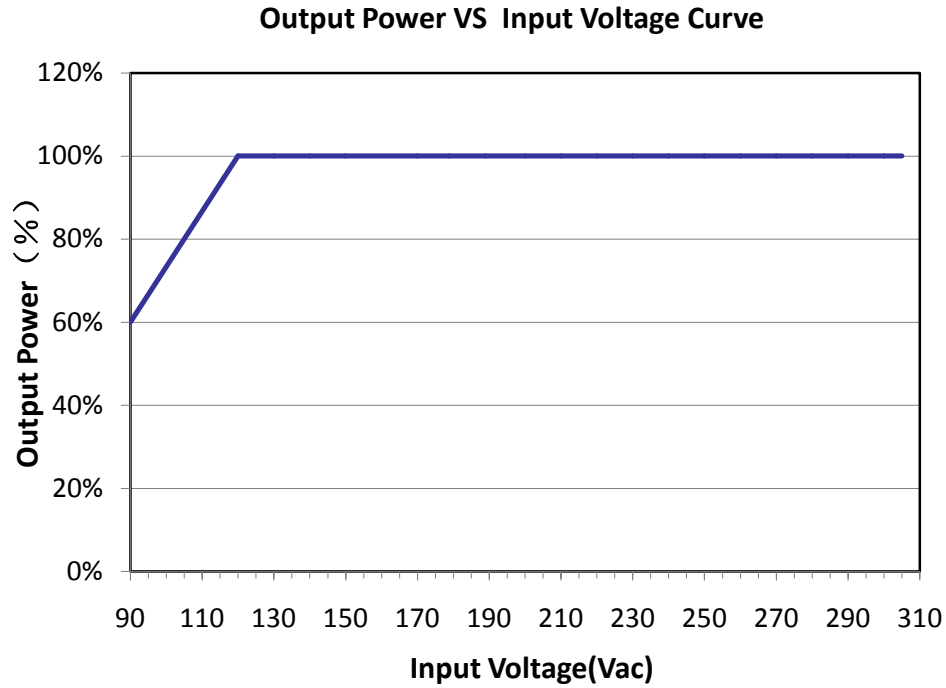

LIFETIME VS CASE TEMPERATURE

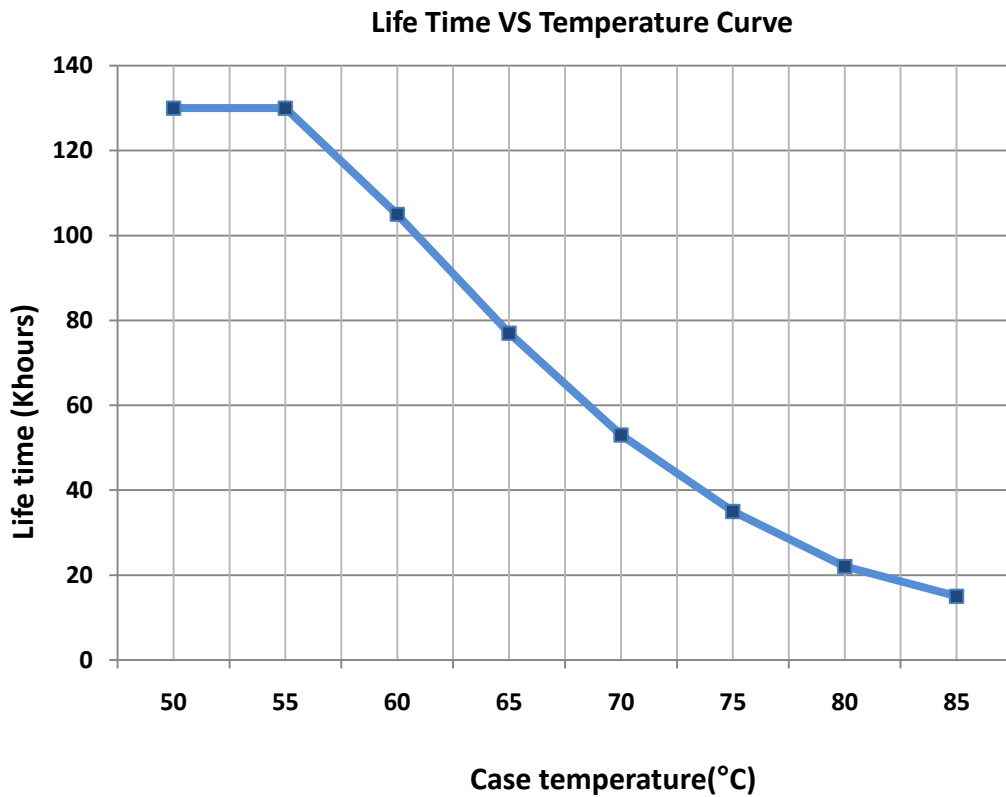

EFFICIENCY VS LOAD

MTP-120X040(Io=3.75A)
Efficiency VS Load

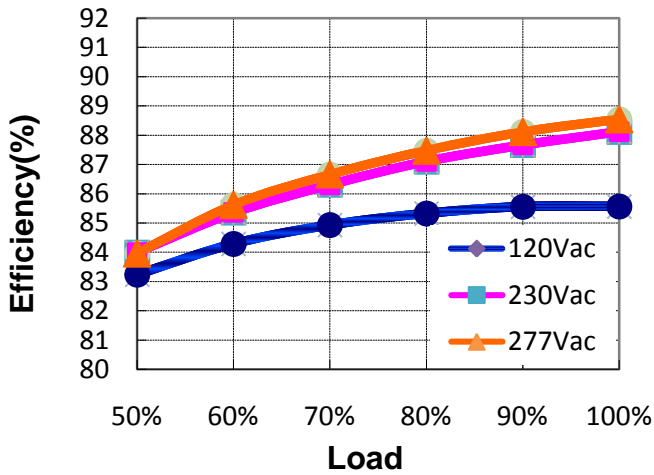

MTP-120X040(Io=3.0A)
Efficiency VS Load

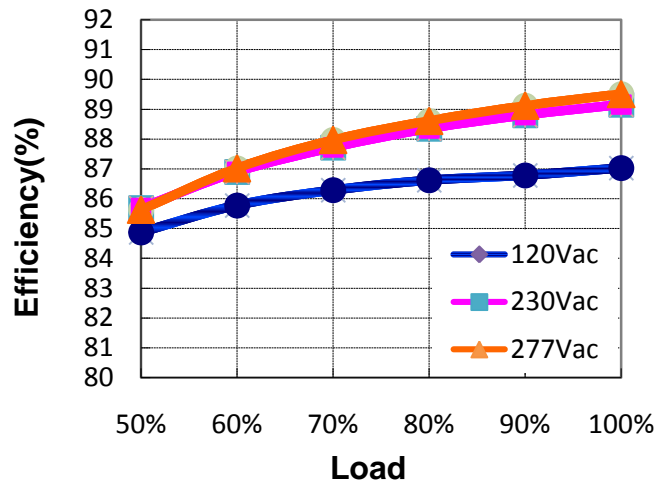

MTP-120X054(Io=2.85A)
Efficiency VS Load

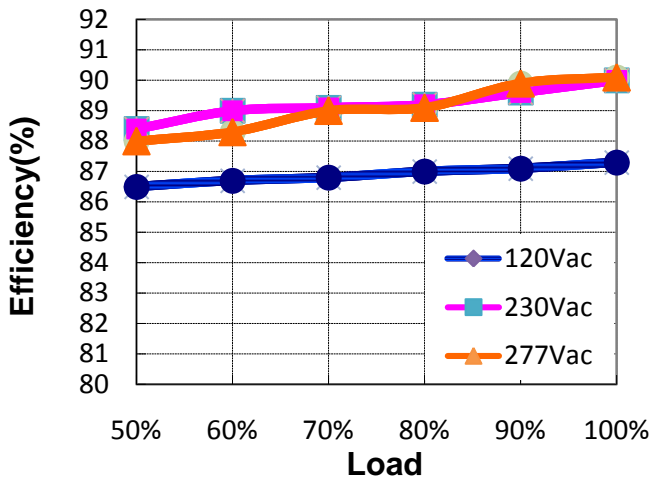

MTP-120X054(Io=2.25A)
Efficiency VS Load

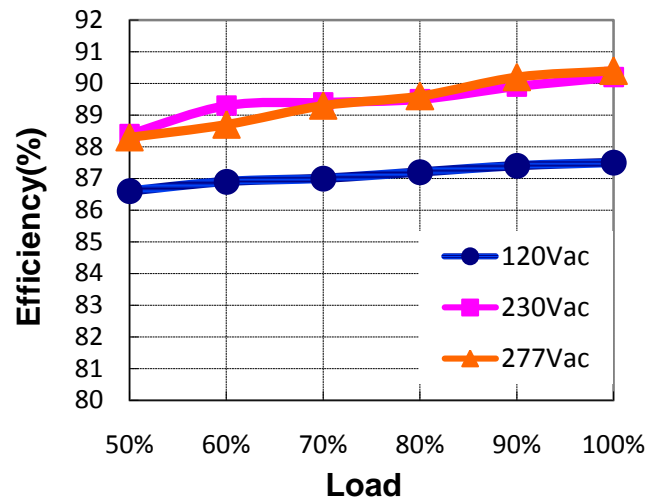

MTP-120X068(Io=2.15A)
Efficiency VS Load

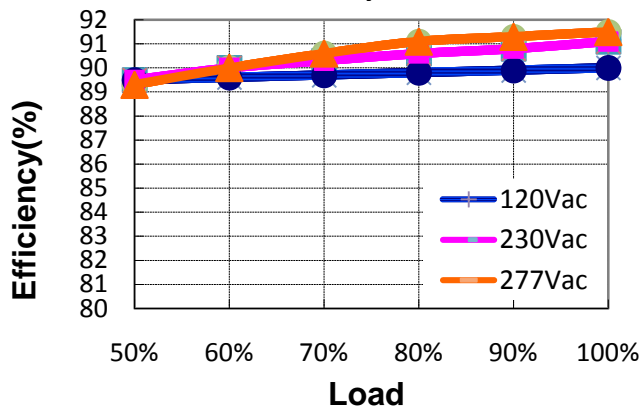

MTP-120X068(Io=1.77A)
Efficiency VS Load

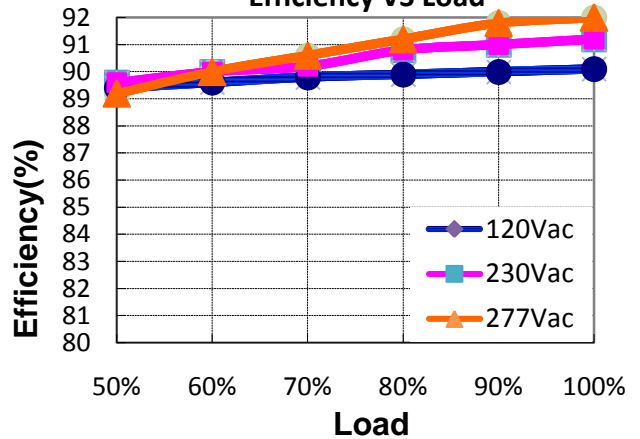

POWER FACTOR VS LOAD

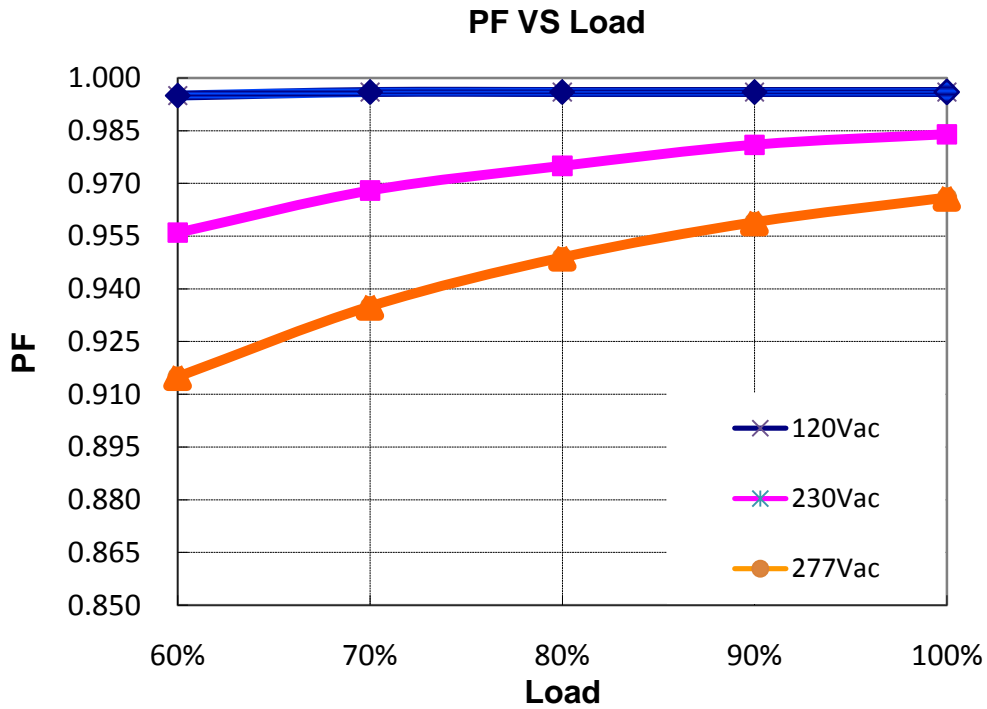

TOTAL HARMONIC DISTORTION

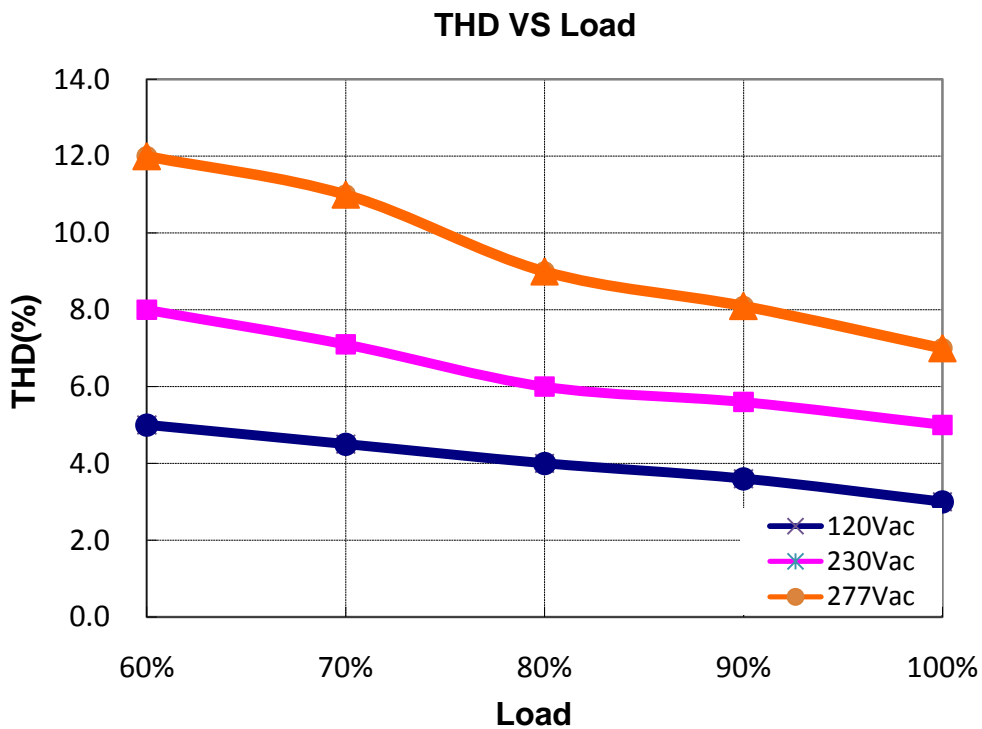

PROTECTIONS

Parameter	Notes
Over Temperature Protection	Decreases output current, returning to normal after over temperature is removed..
Short Circuit Protection	Hiccup mode and auto recovery. No damage will occur when any output is short circuited. The output shall return to normal when the fault condition is removed.
Over Voltage Protection	Run into protection model when output voltage exceeds limit, and return to normal when the fault.

0-10V/PWM DIMMING CURVE

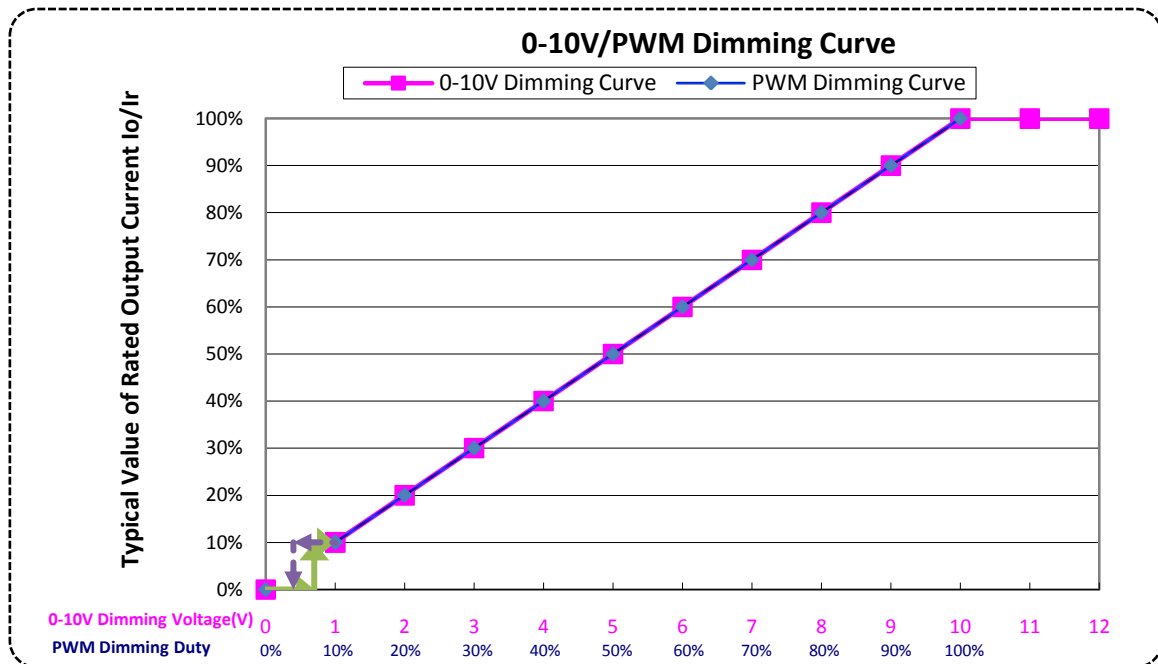

Note:

Dim to off model is realized by decreasing the output voltage, the power supply still has residual voltage when dim to off, so the start up voltage of the lamp should be higher than residual voltage.

MECHANICAL OUTLINE

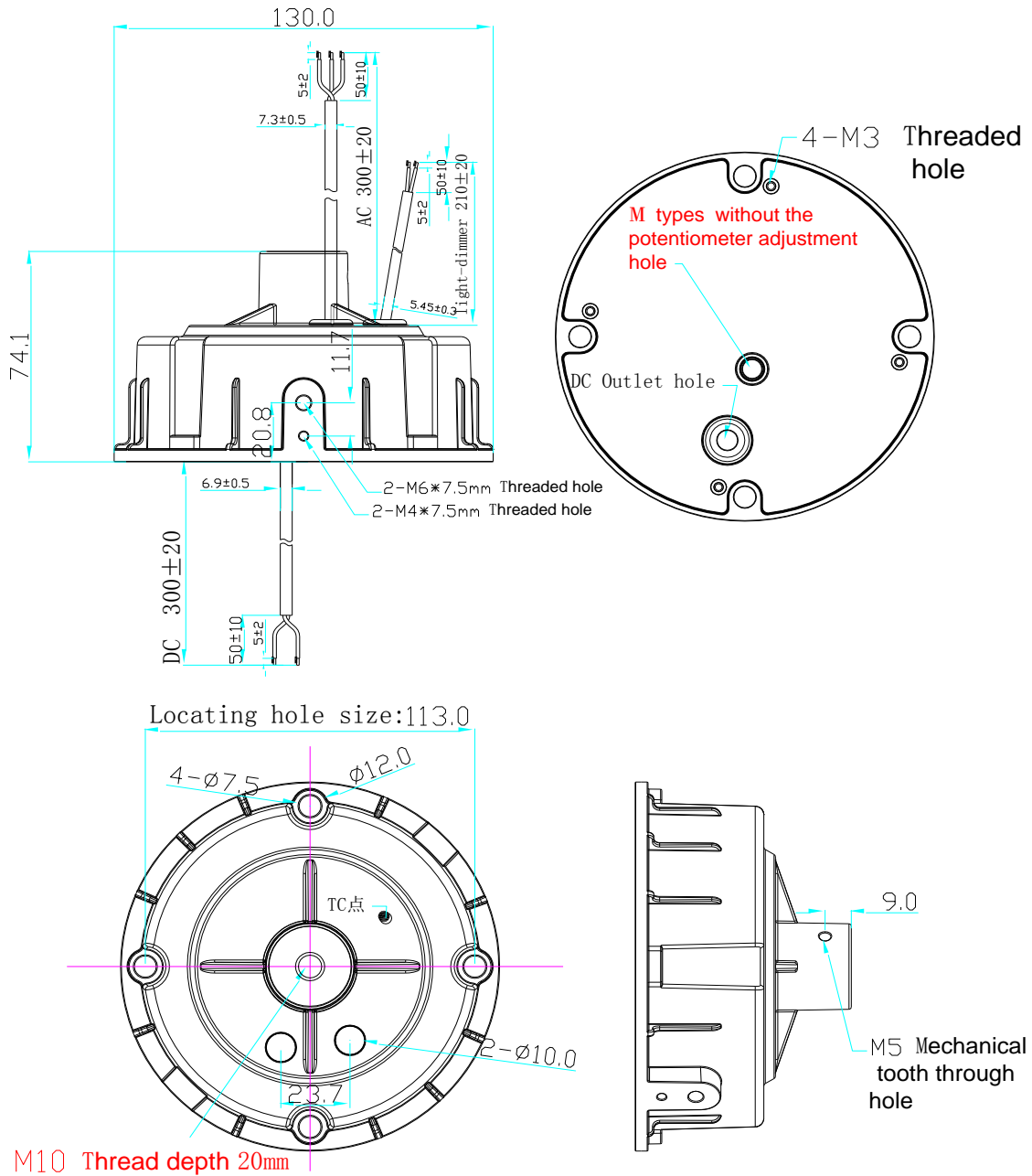

Wire	Specification	Note
Input	CCC+VDE H05RN-F 3x1.0mm ² OD=7.3mm L=300±20mm	3C/CE
	SJOW 18AWG*3C OD=7.8mm L=300±20mm	UL
Output	CCC+VDE H05RN-F 2x1.0mm ² OD=7.0mm L=300±20mm	3C/CE
	SJOW 18AWG*2C OD=7.3mm L=300±20mm	UL
Dimming	UL2733 22AWG*2C OD=5.45mm L=200±20mm	X=M

Note: X=V with no dimming.

Optional Accessories:

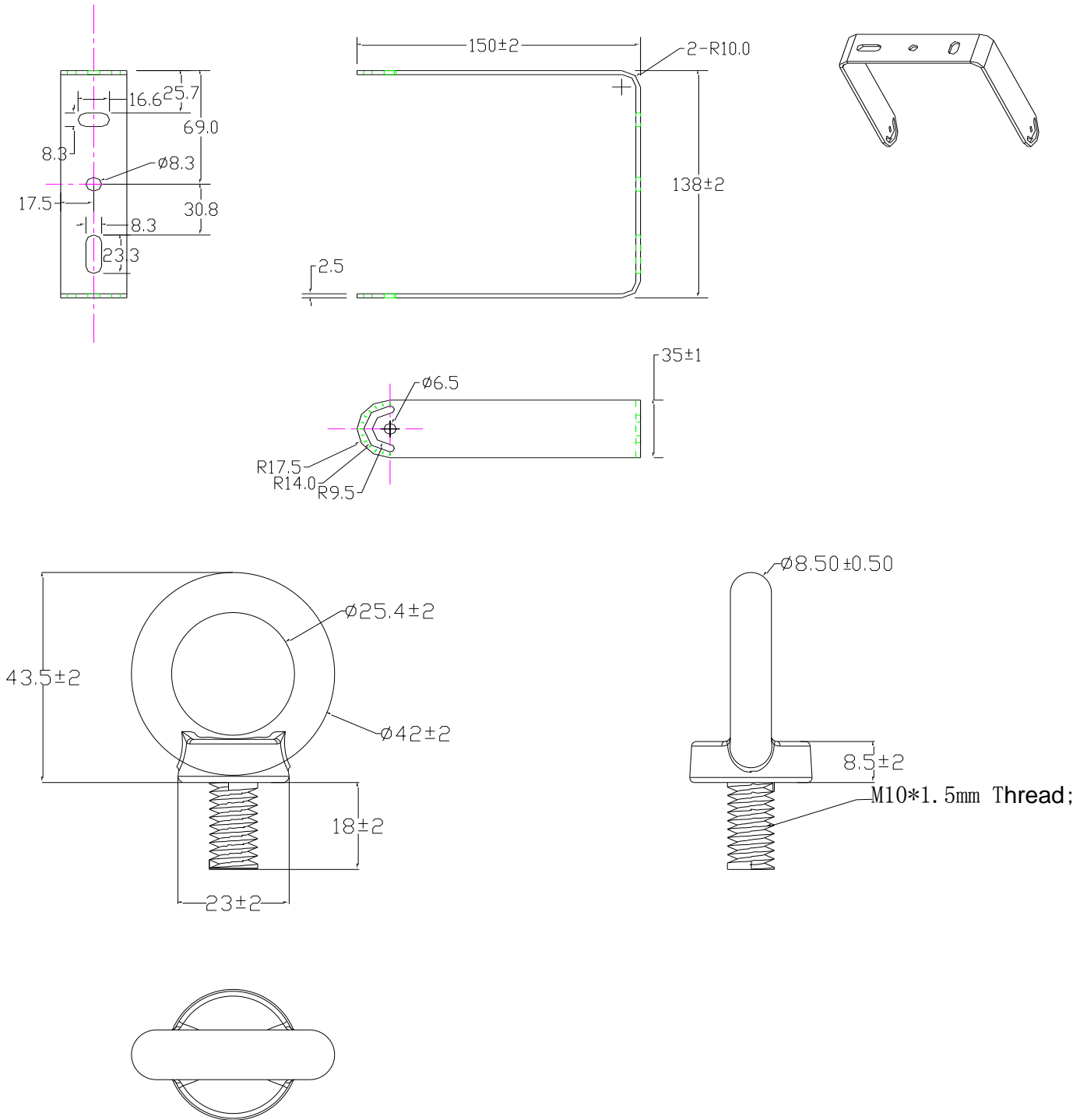



REVISION HISTORY

Version	Description of Change		Date	Notes
	Before	Now		
A.1	—	Datasheets Release	2018-08-20	

Specification for Approval

Product Name: 120W High Bay Driver

Product Model: MTP-120 Series

Rev. A.1

CUSTOMER AUTHORIZED SIGNATURE		
Tested By	Checked By	Approved By
(Company seal)Return one copy to MOSO with approved signature and company seal.		

Prepared By	Checked By	Approved By