

## Introduction



Rated current: 0.5A~100A

Various terminals available( Inlet, wire, solder lug, stud, terminal block)

Custom specific versions available on request



## Features and Benefits

- Pulse group series filters are specially designed to suppress fast and transient pulse group interference based on the principle that absorption and reflection are complementary to each other. Benefit from advanced designed method and many years practical experience in EMC field, FTES1 series filters provided by FILTEMC have excellent attenuation effect of fast and transient pulse group interference.
- Specially designed to meet customers electric fast and transient pulse group test of L, N, G lines.
- Depending on different applications there are different requirement regarding electric fast and transient pulse group test ( variable from 1KV to 4KV), so there is no standard product for this series, but only customized according to specific requirement.
- Very short lead time for product design, able to meet customer' s urgent requirement of passing pulse group test.

## Typical Applications



- Suitable for all kinds of household appliances, watt-hour meter, alarm equipment, electric testing equipment, fuel dispenser and other civilian or military measuring or controlling device compliance with IEC-61000-4-4 or GB/T17626.4-1998 Standard



## Technical Data

Rated Voltage: $V_R$	110/250VAC
Operating Frequency: $f_R$	50/60Hz
Rated Current: $I_R$	0.5~100A@40°C
Test Voltage: $V_{test}$	1760VDC, 3S(line-line); 2000VAC, 3S(line-ground)
Climatic Category(IEC 60068-1)	25/085/21(-25°C /+85°C Damp heat test for 21 days)

## Tabulates

Part No.	Rated Current [A]	Terminals			Weight [g]
					
		-S	-I	-W	
FTES1-1-I	1	---	○	---	95
FTES1-3-I	3	---	○	---	95
FTES1-1	1	---	---	○	65
FTES1-3	3	---	---	○	95
FTES1-6	6	---	---	○	250
FTES1-10	10	M4	---	---	1200

## Outline Drawing and Dimensions(mm)

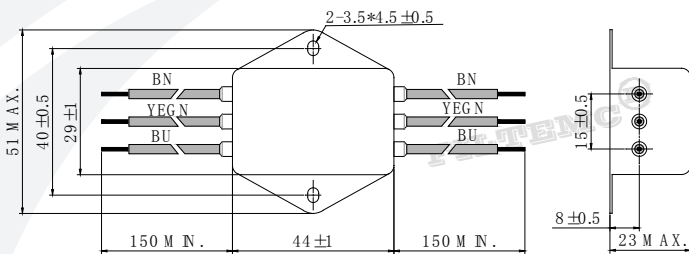

FTES1-1

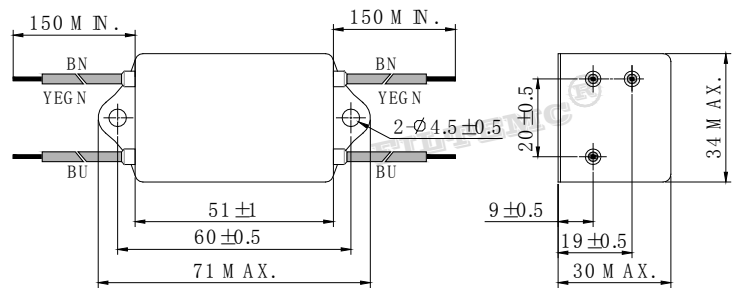

FTES1-3

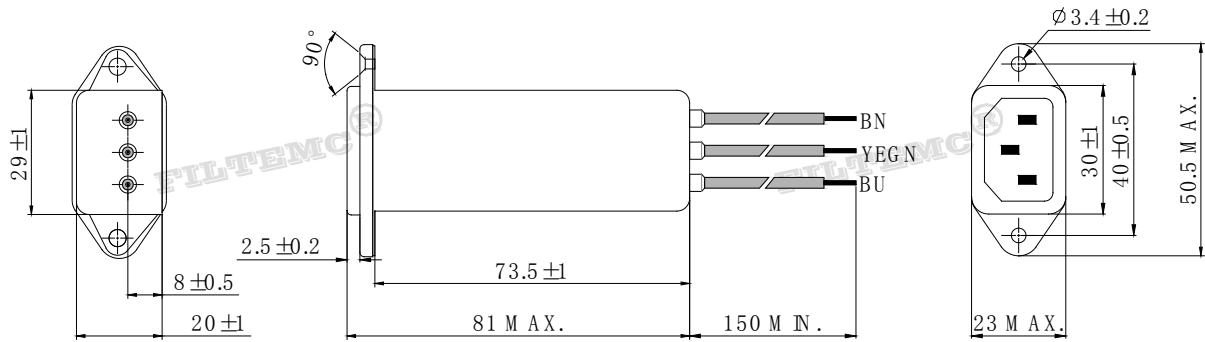

FTES1-1/3-I

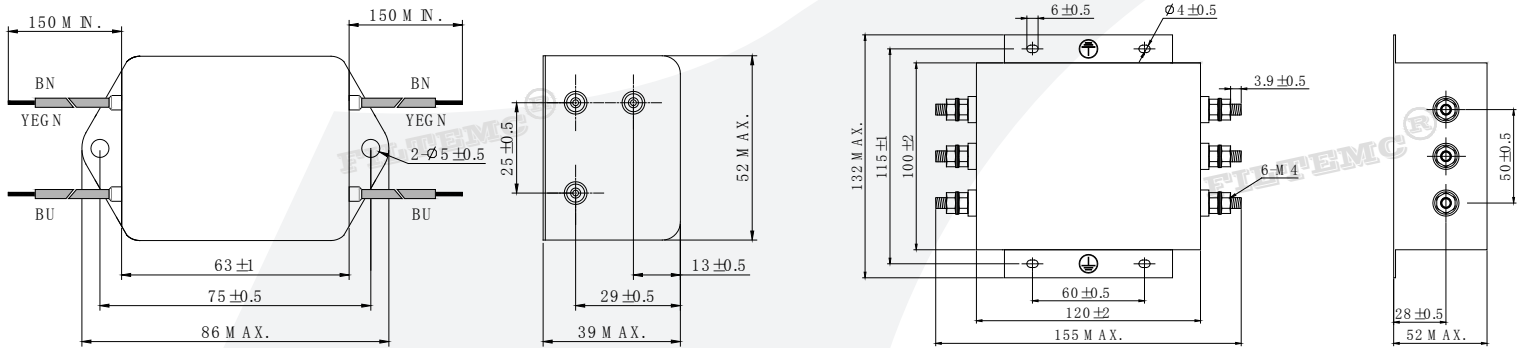

FTES1-6

FTES1-10

## Important Notes on EMI Filter Application

### 1. Storage of EMI Filters:

EMI filters mustn't be left out in the heat of the sun or exposed to the rain, it should be stored in warehouse with good ventilation, surrounding temperature between  $-30^{\circ}\text{C}$  and  $+65^{\circ}\text{C}$ , the highest relative air humidity lower than 90%, and no corrosive liquid or gas.

### 2. Installation of EMI Filters:

- EMI filters should be installed at power input, and the line inside the chassis be as short as possible to reduce radiated interference.
- Both input and output lines of EMI filters neither be intersected nor be tied up by string.
- Make sure the mounting flange fully grounded, and keep the ground cable as short as possible if filters are connected to other equipment.

# FILTEMC

## Pulse Group Series Filters FTES1 Series

- If the terminal is stud, please use two spanners to fasten the screw nut when connecting to avoid stud rotating and thus causing changes to the internal circuit and consequently leading to filters arcing, short circuit, broken down or the filtering effect worsened. First use spanner1 to fix the screw nut near the metal case, then use spanner2 to tighten the screw nut in front( shown as Figure1), otherwise the terminals may be damaged. Apply the same for the connection of other phases.

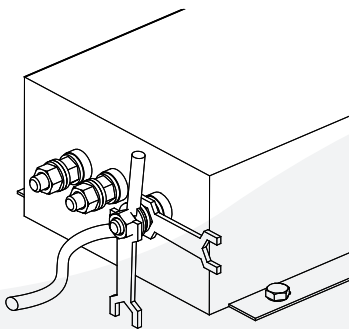

( Figure1 )

- Keep the tools fastening the stud be vertical to the metal case of filter when installing terminal block filters ( shown as Figure2 ), must not tilt( shown as Figure3 ), otherwise the terminal blocks may be damaged.

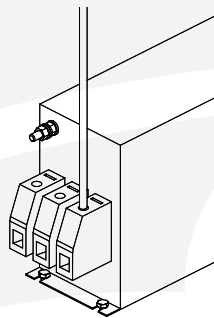

( Figure2 )

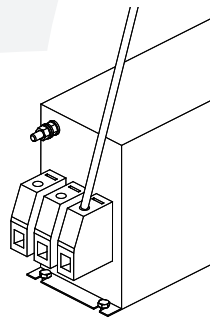

( Figure3 )

### 3. Reminding and Warning:

Please read all the safety warnings and instructions before installing filters and putting them into use:

- Don't take terminals as supporting point when moving filters to avoid the terminals distortion, loosening or broken.
- The protective earth connections shall be the first to be made when the EMC filter is installed and the last to be disconnected.
- Filters generate leakage current, please make sure they are well grounded before putting into operation.
- If the rated current is higher than 50A, we recommend grounding by the earth terminals but not only through the metal case of filters.

- Danger of electric shock: EMC filters contain components that store an electric charge. Dangerous voltages can continue to exist at the filter terminals for longer than five minutes even after the power has been switched off.
- The working conditions of EMI filter should comply with the technical parameters stated on the label, over voltage or overload could cause damage to filters. It is suggested to take proper over current protection measures.
- Current drop occurs when the surrounding temperature rise, fail to follow the current drop requirement may lead to impermissible exceeding of the component temperature, as a result the service life of filters will be shortened after long time running.

## Service and Support

Contact information of Tech. Dept.:

T: 0086-531-58622887

F: 0086-531-58622899

E: [filtemc@filtemc.com](mailto:filtemc@filtemc.com)

A: Building 20, Xinmao Qilu Science and  
Technology City, No. 1 Zidong Road,  
Tianqiao District, Jinan 250119, China

Contact information of Sales:

T: 0086-531-58622888

F: 0086-531-58622886

E: [filter@filtemc.com](mailto:filter@filtemc.com)

Skype: Lisawong2016@hotmail.com

Web.: [www.filtemc.com](http://www.filtemc.com)

# FILTEMC