

SPECIFICATIONS:

Voltage rating: 50V AC/DC
Current rating: 2A AC/DC
Withstanding Voltage: 500V AC/minute
Insulation resistance: 100MΩ Min.
Temperature range: -40°C To +105°C
Contact resistance: 20mΩ Max.

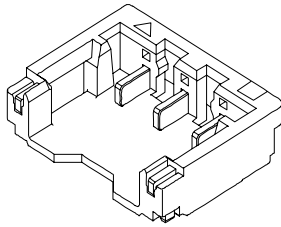
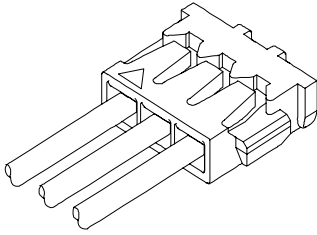

Standards

HSF



RoHS

Wire to Board

Assembly Layout

Right Angle Type

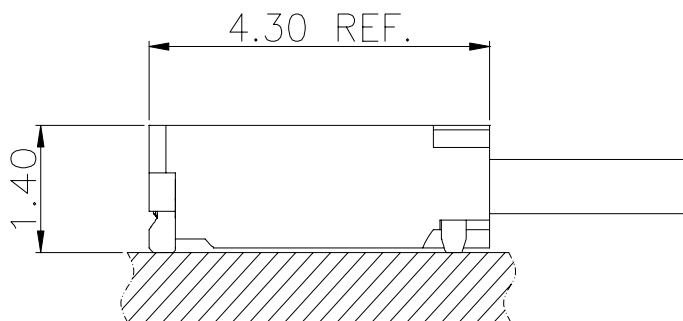

Connectors Expert Around You

1.20mm Pitch housing connector

HOUSING

- Part NO.:AH1201-xP
- Suitable:AT1201T-xP series Terminal
- Mates with:AW1201-xP series Wafer
- Material:Nylon 66,UL94V-0
- Color:Black

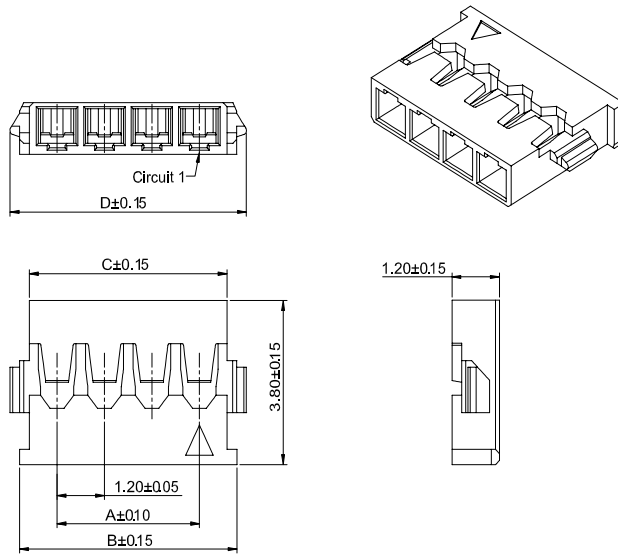

Ordering Information & Dimensions:

Part No.	Dimensions (mm)			
	A	B	C	D
AH1201-02P	1.20	3.10	2.60	3.60
AH1201-03P	2.40	4.30	3.80	4.80
AH1201-04P	3.60	5.50	5.00	6.00
AH1201-05P	4.80	6.70	6.20	7.20
AH1201-06P	6.00	7.90	7.40	8.40
AH1201-07P	7.20	9.10	8.60	9.60
AH1201-08P	8.40	10.30	9.80	10.80
AH1201-09P	9.60	11.50	11.00	12.00
AH1201-10P	10.80	12.70	12.20	13.20
AH1201-11P	12.00	13.90	13.40	14.40
AH1201-12P	13.20	15.10	14.60	15.60
AH1201-13P	14.40	16.30	15.80	16.80
AH1201-14P	15.60	17.50	17.00	18.00
AH1201-15P	16.80	18.70	18.20	19.20

Wire to Board

1.20mm Pitch crimp terminal connector

TERMINAL

- Part NO:AT1201T-xP
- Applicable wire:AWG#28-#30
- Material:Phosphor Bronze
- Finish:Gold over Nickel
- Used in AH1201-xP series Housing

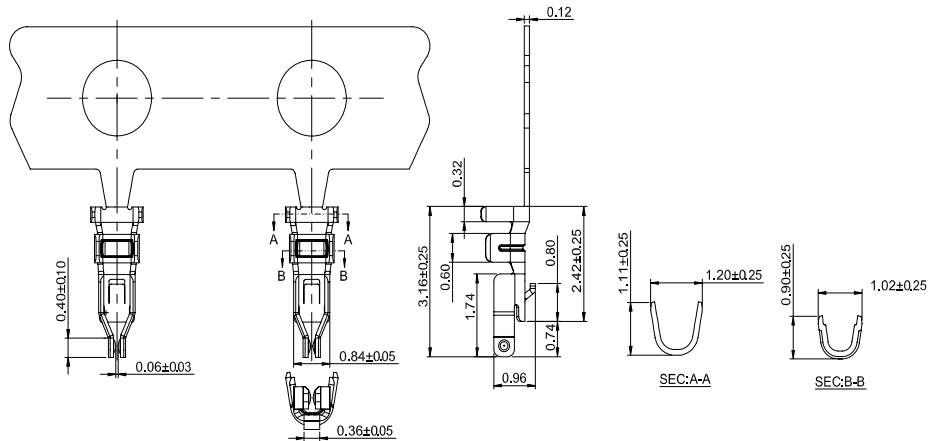

Ordering information & Specifications

Part NO.	Wire Range	Insulation O.D.	Material	Finish	Qty/reel
AT1201-GP	AWG#28-#30	0.63mm(max)	Phosphor Bronze	Gold over Nickel	30,000 PCS

1.20mm Pitch 90° wafer-smt connector

WAFER

- Part NO:AW1201R-S-xP
- Material:
- Pin:Phosphor Bronze/Gold over Nickel
- Insulator:Nylon 6T, UL94V-0
- Solder Tab:Phosphor Bronze/Tin over Nickel
- Mates with:AH1201-xP series Housing
- Color: Black

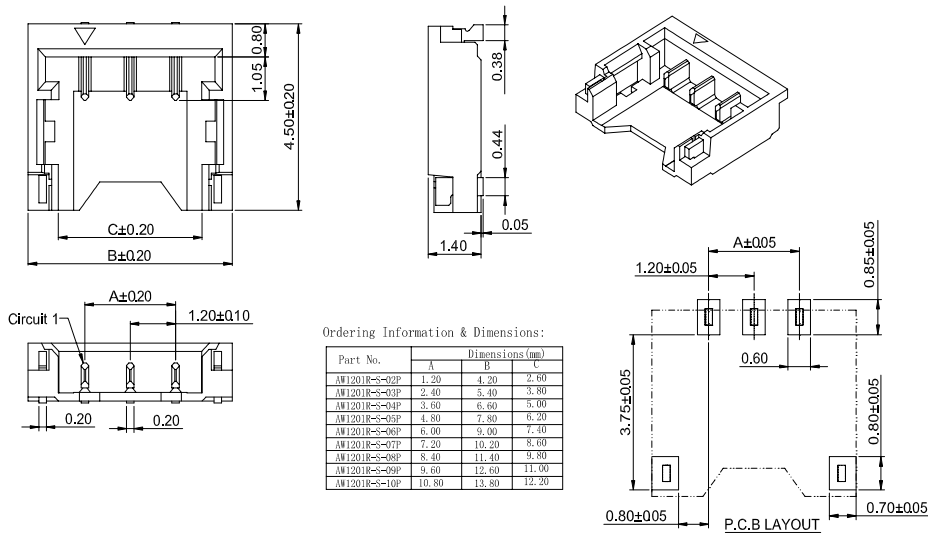

Ordering Information & Dimensions:

Part No.	Dimensions (mm)		
	A	B	C
AW1201R-S-02P	1.20	4.20	2.60
AW1201R-S-03P	2.40	5.40	3.80
AW1201R-S-04P	3.60	6.60	5.00
AW1201R-S-05P	4.80	7.80	6.20
AW1201R-S-06P	6.00	9.00	7.40
AW1201R-S-07P	7.20	10.20	8.60
AW1201R-S-08P	8.40	11.40	9.80
AW1201R-S-09P	9.60	12.60	11.00
AW1201R-S-10P	10.80	13.80	12.20

Connectors Expert Around You

1.20mm Pitch housing connector

HOUSING

- Part NO.:AH1201B-xP
- Suitable:AT1201T-xP-B series Terminal
- Material:PBT,UL94V-0
- Color:Natural

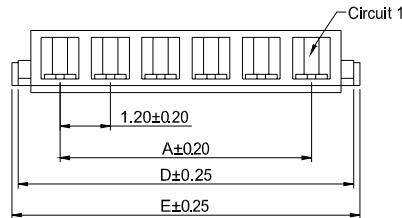
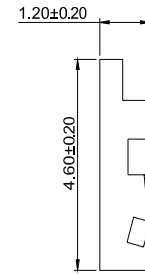
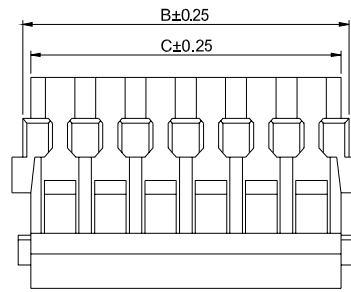

Ordering Information & Dimensions:

Part No.	Dimensions (mm)				
	A	B	C	D	E
AH1201B-02P	1.20	2.98	2.60	3.20	3.50
AH1201B-03P	2.40	4.18	3.80	4.40	4.70
AH1201B-04P	3.60	5.38	5.00	5.60	5.90
AH1201B-05P	4.80	6.58	6.20	6.80	7.10
AH1201B-06P	6.00	7.78	7.40	8.00	8.30

Wire to Board

1.20mm Pitch housing connector

HOUSING

- Part NO.:AH1201C-xP
- Suitable:AT1201T-xP-B series Terminal
- Material:PBT,UL94V-0
- Color:Natural

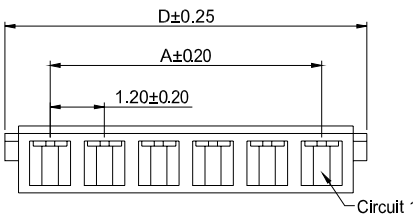
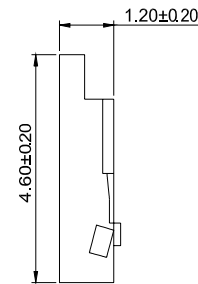
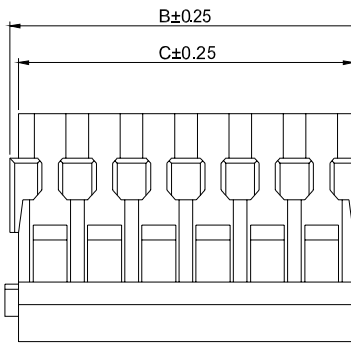

Ordering Information & Dimensions:

Part No.	Dimensions (mm)			
	A	B	C	D
AH1201C-02P	1.20	2.98	2.60	3.20
AH1201C-03P	2.40	4.18	3.80	4.40
AH1201C-04P	3.60	5.38	5.00	5.60
AH1201C-05P	4.80	6.58	6.20	6.80
AH1201C-06P	6.00	7.78	7.40	8.00

1.20mm Pitch crimp terminal connector

TERMINAL

- Part NO:AT1201T-xP-B
- Applicable wire:AWG#28-#32
- Material:Phosphor Bronze
- Finish:Tin Plated or Gold
- Used in AH1201-xP series Housing

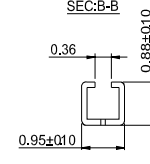
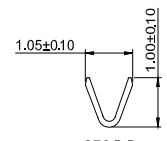
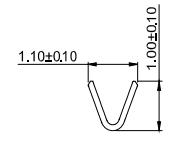
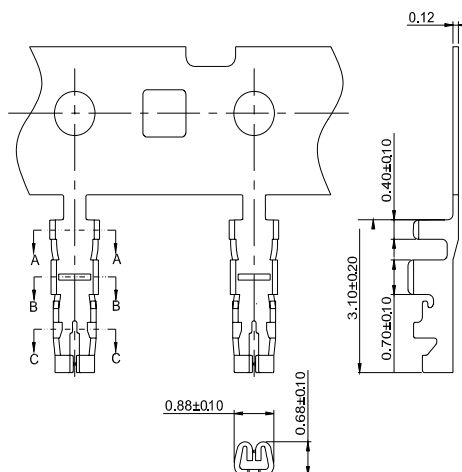

Ordering information & Specifications

Part NO.	Wire Range	Insulation O.D.	Material	Finish	Qty/reel
AT1201T-TP-B	AWG#28-#32	0.63mm(max)	Phosphor Bronze	Tin over Nickel	30,000 PCS
AT1201T-GP-B	AWG#28-#32	0.63mm(max)	Phosphor Bronze	Gold over Nickel	30,000 PCS