

1.32W

125LM

10°*65°

IP68

LifeSpan
50,000h

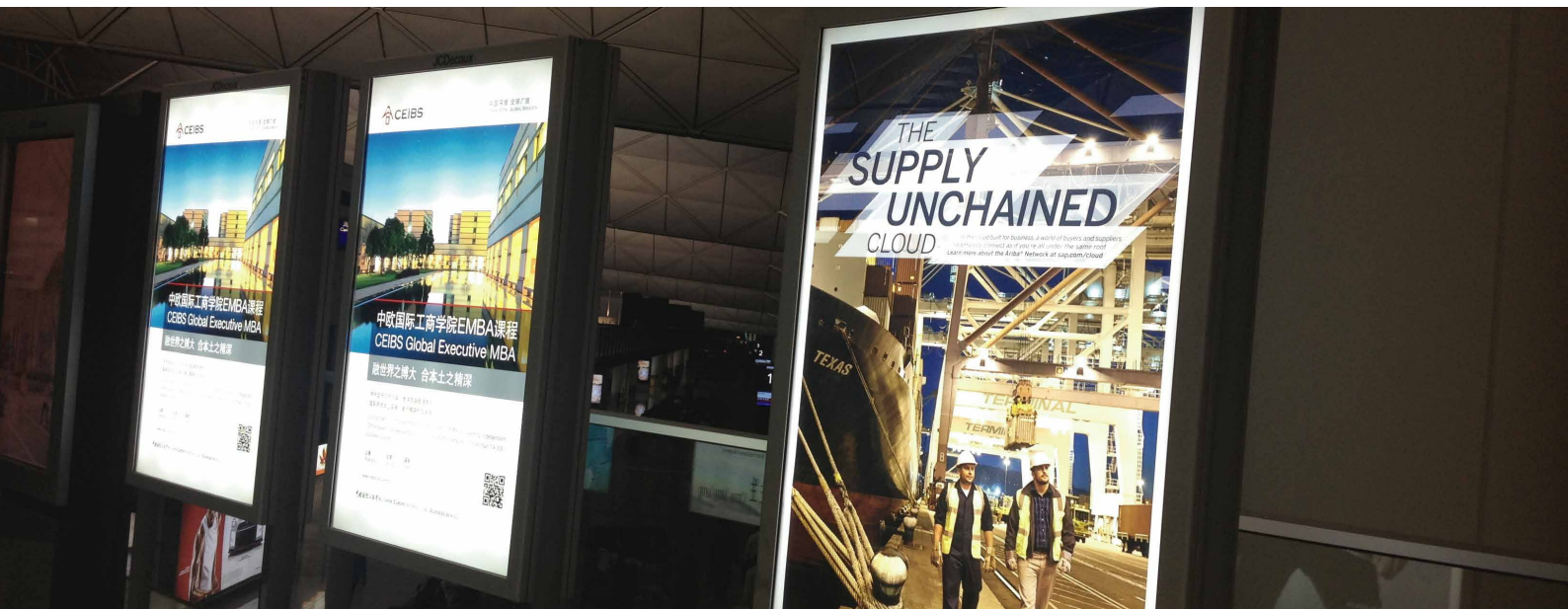

Features >

- Sourced by high output SMD3030, good color conformity and no spot.
- 99.99% gold thread, pure copper bracket coated with silver.
- SDCM≤5 each BIN.
- Special lens design, 10*65°beaming angle with even light.
- Overmoulded: anti-dusting, anti-moisture, waterproof, anti-shock.
- 20 pcs Max. in a series connection.
- CE, ROHS and UL certified.

Application >

- Best for 15-30cm depth double-sided light box or 8-20 cm depth single-sided light box at airports, metros, banks, buildings and shopping malls, etc.

Parameters >

Items	Parameters
Part Number	ZF01BB3
CCT (K)	7000K
Beaming Angle (°)	10°*65°
CRI (Ra)	≥75
Luminous Flux (lm)	125
Voltage (V)	DC12
Power (W)	1.32
Driving Method	Inner constant Current
Dimension (mm)	43*23*11.6
Weight (g)	9.8
Working Tem. (°C)	-25 ~ +60
Storage Tem. (°C)	-25 ~ +70
Protection Grade	IP68

Dimension >

Unit:mm

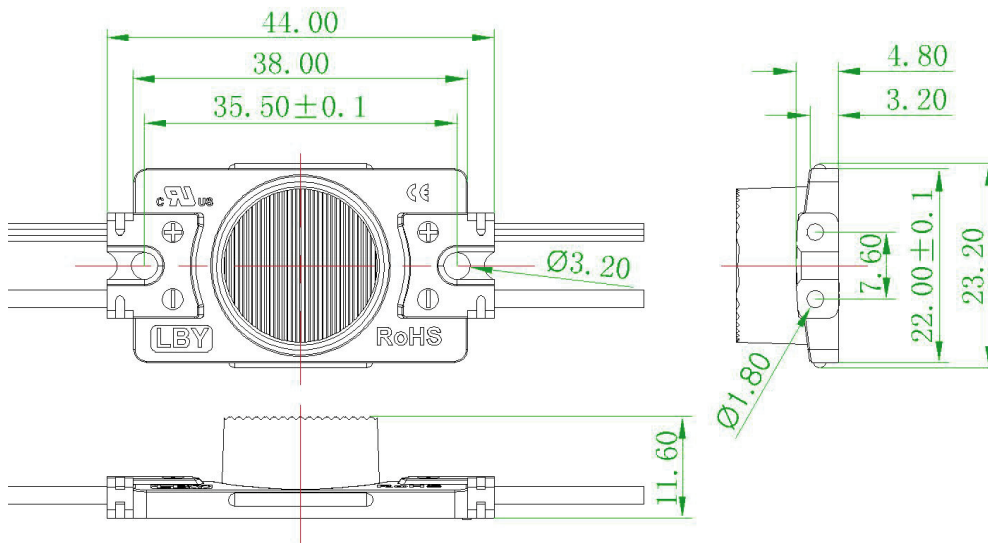

Beaming Angle >

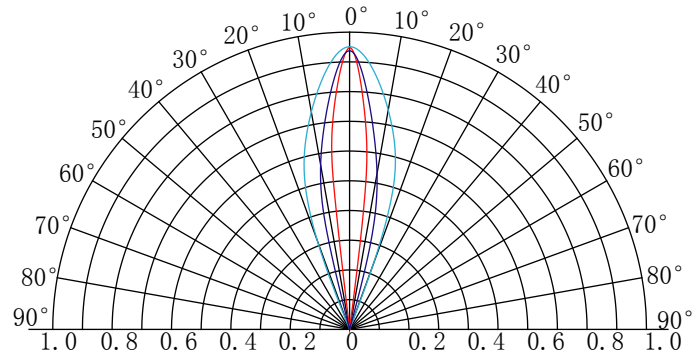

Reference Scheme >

Depth(mm)	Size(mm)	Density(pcs/m ²)	Illumination(lux)
120	1000*1000	30	650-700
150	1000*1000	30	600-650
180	1000*1000	30	500-600
200	1000*1000	30	500-550

Remark:

- The transmittance of the advertising fabric was 32%.
- The above data is for reference only.

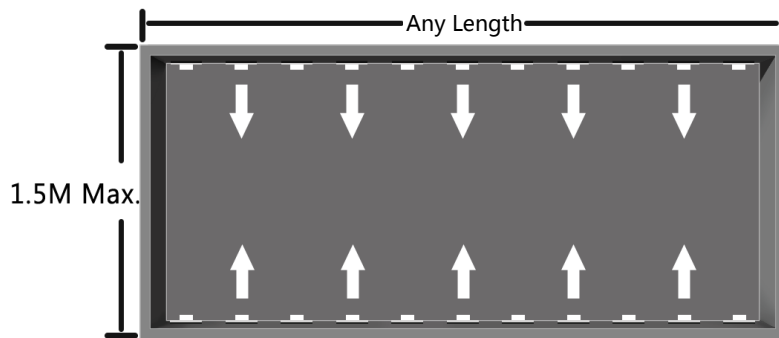

Wire Connection >

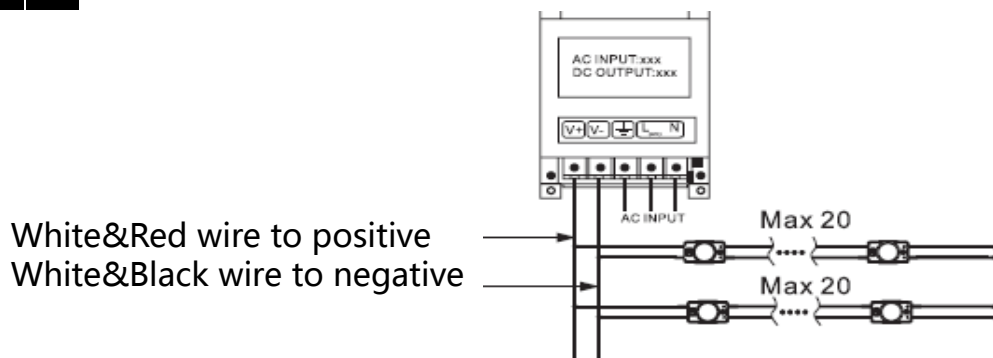

Packing

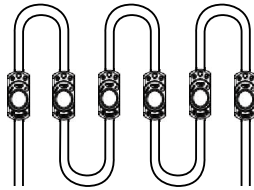

20pcs per string

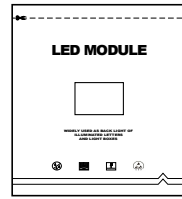

100pcs in an antistatic bag

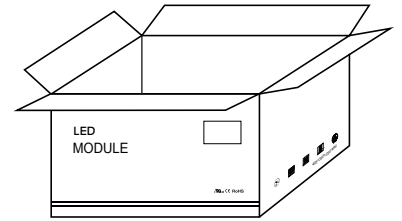

1000pcs in a carton

Packing Specification

- Antistatic bag adopted
- Packing information

Part Number	ZF01BB3
Carton Dimension(mm)	490*450*220
Bags per carton	10
Quantity per carton(pcs)	1000
Net Weight(kg)	8.3(1±10%)
Gross Weight(kg)	9.5(1±10%)

- Due to the packing manner difference, please subject to the original products in case of discrepancy found between the picture and actual product.

Instruction

- When installing the product, please switch off the power
- Please use constant voltage power supply and leave 20% or more balance of its total power
- Make isolation and corrosion prevention on all wiring points and wire ends
- The maximum series connection quantity for ZF01BB3 is 20 pcs , please do not exceed this number
- The products can be installed by screws, rivets as well as silicon gel, while please do not use Acidic or alkaline adhesive
- The high power LEDs generates more heat, so please install the products on the surface of material with good heat dissipation such as metallic or aluminium panel
- For single side light box, in order to get better and even lighting effect, you can put the products more closer to unilluminated back and attach white reflective poly sheet or sheet with similar function on the inner back.

Declaration



- Warranty: 5 years.
- In order to ensure the safety, the broken wires needs to be replaced by the manufacturer or the service agent, or by the staff with the similar qualification.
- The given data in the specification was based on the laboratory testing, there may be discrepancy found in the actual products.
- The given drawings in the specification are only for reference, there may be discrepancy found in the actual products.
- The products are subject to change without prior notification.



RoHS

Company Address:

Rm. WS, 9F, LuBan Building, Hongli West Road, Futian District, Shenzhen, China 518034

Factory Address:

No. B, Xinyongfeng Industrial Area, Yingrenshi Village, Shiyuan Town, Bao'an District, Shenzhen, China 518000

TEL: +86-755-83544570

FAX: +86-755-83056229

Website: www.lbyled.com

E-mail: info@szlby.cn



LBY LED
signs never been so easy